

Complete Manual

SR-S4000

Electronic Cash Register

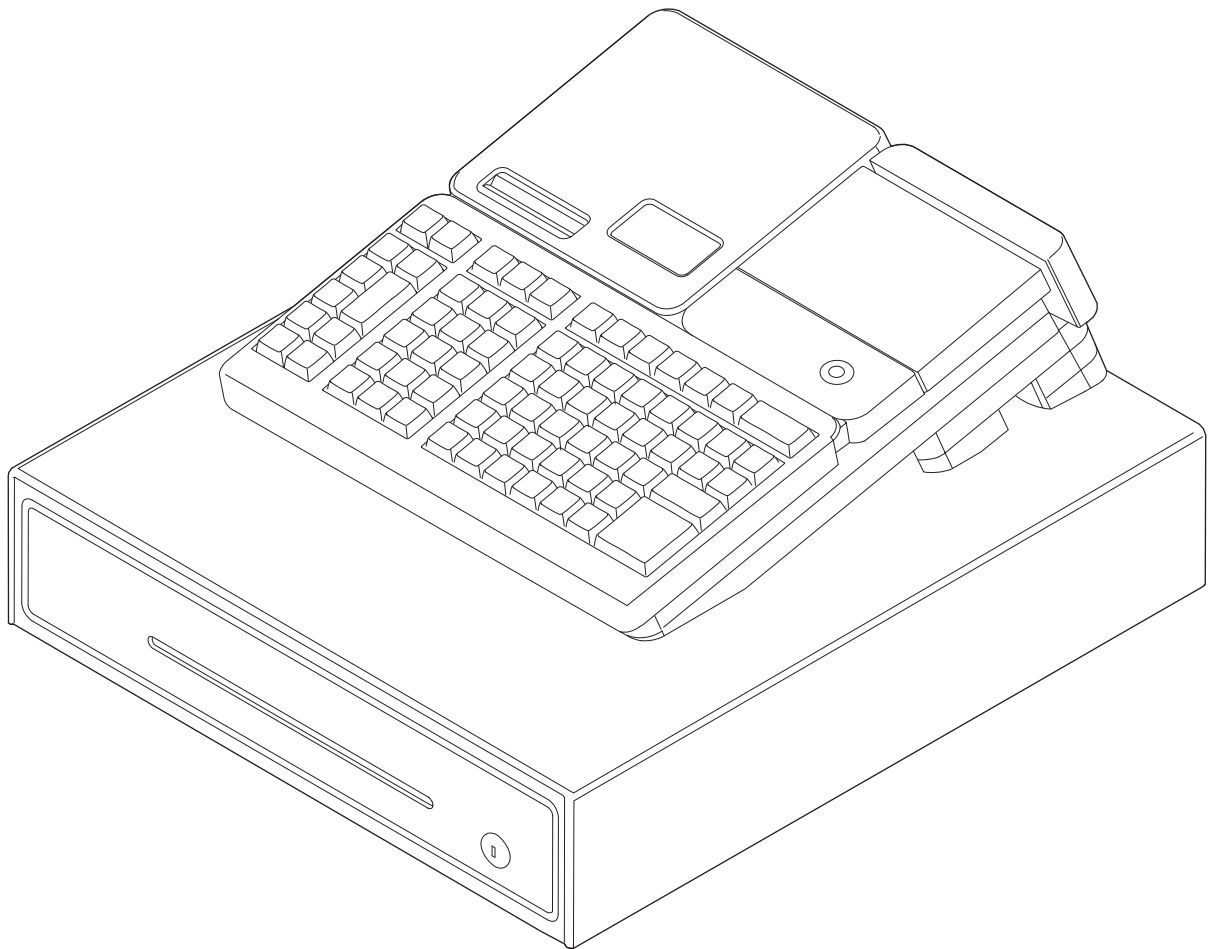

(M size drawer)

Introduction

Thank you very much for purchasing this CASIO electronic cash register. START-UP is QUICK and EASY!

For the basic settings of your cash register, please see “Quick Start Guide”.

Original Carton/Package

If for any reason, this product is to be returned to the store where purchased, it must be packed in the original carton/package.

Location

Locate the Cash register on a flat, stable surface, away from heaters or areas exposed to direct sunlight, humidity or dust.

Power Supply

Your cash register is designed to operate on standard household current (120 V, 220 V, 230 V, 240 V; 50/60 Hz). Do not overload the outlet by plugging in too many appliances.

The mains plug on this equipment must be used to disconnect mains power. Please ensure that the socket outlet is installed near the equipment and shall be easily accessible.

Trademark



SD and SDHC Logos are trademarks of SD-3C, LLC.



The Bluetooth wordmark and logo are registered trademarks of Bluetooth SIG, Inc. and are used by permission granted to Casio Computer as a certified logo user.

Interference with the Operation of Other Equipment (Using Wireless Data Communication)





- Keep your Cash Register well away from anyone wearing a pacemaker. Radio waves emitted by the Cash Register can affect the operation of a pacemaker.



Safety Precautions	E-4
Precautions for Use.....	E-8
Regulatory Information.....	E-10
To use the cash register's basic function	E-11
Getting started.....	E-12
Getting to know your cash register	E-18
How to read the printouts	E-23
How to use your cash register	E-24
Before opening your store.....	E-25
Registering items in departments	E-26
Basic setups and registrations	E-29
Other registrations	E-37
Daily sales reports.....	E-48
Advanced programmings and registrations	E-51
Advanced registrations.....	E-53
Character settings	E-64
Advanced programmings	E-72
Programming functions of departments and PLUs in a lump	E-86
Programming functions of departments and PLUs individually	E-89
Printing programmed data.....	E-98
Printing various sales reports.....	E-103
Bluetooth setting	E-111
Setting Bluetooth pairing.....	E-111
Using an SD card	E-113
Restoring backup data (automatically backed up setting data) from built in flash memory	E-116
POP setting	E-116
Handling of the cash drawer	E-117
Before you consider it as a problem	E-119
Specifications	E-125

Safety Precautions

- Please read this “Safety Precautions” thoroughly and use the product accordingly.
- Please pay due attention to the following symbols to help you use the product safely and properly and to avoid any personal injury or damage to the product.

 Danger	If this symbol is ignored and the product consequently misused, it can result in serious personal injury and/or death.
 Warning	This symbol indicates the contents that may cause death or serious injury to a person when the product is misused ignoring this symbol.
 Caution	This symbol indicates the contents that may cause injury to a person or property damage when the product is misused ignoring this symbol.

- The “pictorial indications” in this manual have the following meanings.

	⚠ This symbol means “to be careful = caution”. The example at left is “caution for electrical shock”.
	⊘ This symbol means “must not do = prohibited”. The example at left is “prohibited to disassemble”.
	● This symbol means “something must be done = instruction”. The example at left is “disconnect the power plug from the outlet”. The “instructions difficult to express in picture” are indicated by ⓘ.

Danger

If liquid that leaked from a battery gets in your eye, on your skin or clothes, deal with it immediately as follows.



1. Immediately rinse it off with lots of water.
 2. Immediately get medical treatment.
- Failing to act may result in a rash or loss of sight.

Warning

Power Cords and Plugs



- Do not twist, pull, heat, modify, or place anything heavy on the power cord. This may damage the power cord and result in fire or electrical shock.
- Refrain from routing cords under this product. If the power cord is damaged, it may cause a fire or an electrical shock.
- Contact the dealer or the CASIO service representative when the power cord is damaged (wire is exposed or disconnected). Using the power cord in such condition may result in fire or electrical shock.
- Securely insert the power plug all the way.
- Do not touch the power plug with wet hands. This may result in electrical shock.

Safety Precautions

Warning

Power supply voltage



- Do not use with any voltage other than the indicated power supply voltage. This may result in fire or electrical shock.
- Do not overload the outlet with wires. This may result in fire or electrical shock.

Do not disassemble or modify



- Do not disassemble or modify the product. There are high voltage parts and sharp parts inside. Touching them may result in injury or electric shock, or cause a malfunction or fire.

Do not let any foreign object or water get inside



- Do not insert or drop metal object or flammable object inside from the opening.
- Do not spill any liquid such as water from a flower vase, coffee, juice, etc., inside this product.



- Disconnect the power plug from the outlet and contact the dealer where the product was purchased or the CASIO service representative when a foreign object or water got inside the product. Using the power cord in such condition may result in fire or electrical shock.

Do not use the product in abnormal condition



- It may result in fire or electrical shock when the product is used in abnormal condition such as overheating, it is smoking, have strange odor, etc. Immediately disconnect the power plug from the outlet and contact the dealer where the product was purchased or the CASIO service representative.

Caution

Installation location



- Do not place in unstable locations such as on an unsteady table or an inclined location. It could fall and cause injury.
- Do not place in a location with high humidity or dust. This may result in fire or electrical shock.
- Do not place in a location exposed to oil smoke or humidity such as close to cooking table or humidifier. This may result in fire or electrical shock.
- Do not place in a location close to heating devices such as a stove or a heater, or location directly exposed to hot air. This may result in fire.
- The main plug on this equipment must be used to disconnect mains power.
- Select the outlet where the power cord of this product is easily reached, and plug/unplug of the power plug can easily be performed.

Do not place anything on top



- Do not place flower vase or flower pot, cup or container with liquid, or metal object.
- Do not place anything that is hot such as cigarette.
- Do not place anything heavy.
- Do not place your hands and lean on the product.

Safety Precautions

Caution

When moving the product



- Always disconnect the power plug from the outlet before moving.
- Always hold onto the plug when unplugging the power plug.
- Pulling on the power cord may damage the cord, resulting to fire or electrical shock.

LCD



- Do not press hard on the LCD or apply strong impact. This may crack the glass on the LCD, resulting to injury.
- Never touch the liquid from inside when the LCD is cracked. This may result in irritation to the skin.
- Immediately rinse the mouth and contact the physician when the liquid inside the LCD gets inside the mouth.
- Rinse for minimum of 15 minutes with clean running water and contact the physician when the liquid inside the LCD gets in the eye or on the skin.

Adjustment of display



- Do not put your hands at the back of the display while it is moving to adjust its angle. Doing so may result in an injury.
- Do not put your fingers between the sub display and the product when you put it back. Doing so may result in an injury.

Drawer



- Take caution with the face of a child or pregnant person when opening a drawer.
- Do not lean on the drawer when the drawer is opened. It could fall and cause injure.



When changing the roll paper



- Beware of your hair or scarf not to get caught in a gear or the platen arm while you are changing the roll paper.
- Do not touch the head of the printer. Doing so may result in an injury or burn.
- Do not oils to adhere to the paper roll or paper holder. Doing so may cause printing errors.

Cleaning



- Unplug the power plug from the outlet for safety when cleaning.
- Clean the blades and surrounding of the blades of the power plug with a dry cloth at least once a year. Dust accumulation may result in fire. Do not use detergent to clean the power plug.

When not using for a long period



- Unplug the power plug from the outlet for safety when not using this product for a long period such as consecutive holidays.

Caution

Only use the specified batteries.



- Do not disassemble, modify or short-circuit them.
- Do not put them in fire or water or heat them.
- Do not mix new and old batteries or different types of batteries.
- Orient the terminals +- correctly.
- Remove the batteries if the system will not be used for a long time.
- After batteries are spent, dispose of them as per local regulations.
- Do not try to recharge dry cell batteries.

Disposing of batteries:



- Make sure that you dispose of used batteries in accordance with the rules and regulations in your local area.

Precautions for Use

Read the following items thoroughly and use this product properly. CASIO bears no responsibility whatsoever for malfunction or damage caused by handling not following below contents. Please note that it will also result in charged repair, and actual cost required for repair will be charged, even if it is within the warranty period.

■ Installation Location

Do not place in a hot or dusty location, or in any location exposed to oily smoke or water. Never store or leave in following locations. This could erase the memory and cause a malfunction or result in deformation of the case.

- Temperature of 0°C or lower
- Inside vehicles in summer
- Close to air conditioner
- Under direct sunlight
- Temperature of 40°C or higher

Avoid using this product in following locations.

- Outdoor
- Close to equipment that will become hot such as range, electrical heater, etc.
- Location exposed to water or steam
- Location with severe change in environment such as temperature, humidity, etc.
- Location where corrosive gas or saline matter is generated
- Location where dirt or dust is generated
- Location with vibration
- Location prone to static electricity

■ Others

- Prepare separate AC power supply from the power line for motor, ice maker, microwave oven, etc., which may generate noise.
- Do not touch the power switch with wet hands. This may result in electrical shock.
- Wipe thoroughly with dry cloth, etc., when there is any water droplet on the device.
- Do not use any volatile chemical such as thinner, benzine, cosmetics, etc., for cleaning. Wipe with dry soft cloth when this product gets dirty. The display section may be scratched when scuffed strongly with a cloth.
- When the capacity of the internal memory protection battery is insufficient and there is no power supply available due to a power outage, malfunction or other reason, the memory content might be erased.

Precautions for Use

■ Take Advance Notice of the Following

- The content of this manual may be changed without prior notice due to improvement or specification change of the product.
- Please note that CASIO bears no responsibility for damage, loss of profit, or any claim from third party due to loss or change of data caused by usage, malfunction, or repair of this product.
- The copyright for this manual and all rights related to the software described in this manual are the property of CASIO Computer Co., Ltd. The unauthorized reproduction of this manual in whole or part is prohibited without the written permission of CASIO.
- The content of this manual was created with all possible care, but please contact us if there is any unclear point, mistake, omission, etc., in this manual.
- The screen or illustration used in this manual may be different from the actual product. The keys and icons are described in simplified manner.
- Weld Line
The line on the exterior of the product is called “weld line”, which is created at the time of plastic forming, and it is not a crack or a scratch. This will not interrupt the usage.

■ When the cash drawer does not open!

In case of power failure or the machine is in malfunction, the cash drawer does not open automatically. Even in these cases, you can open the cash drawer by pulling drawer release lever (see the figure on the right).

Important: The drawer will not open, if it is locked with a drawer lock key.

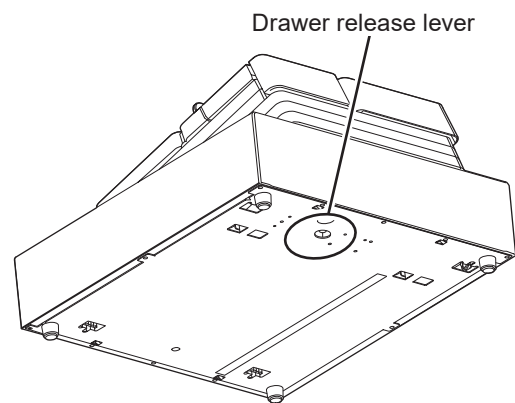

SR-S4000



Manufacturer: CASIO COMPUTER CO., LTD.
6-2, Hon-machi 1-chome, Shibuya-ku, Tokyo 151-8543, Japan
Responsible within the European Union: CASIO Europe GmbH
CASIO-Platz 1, 22848 Norderstedt, Germany
<http://www.casio-europe.com>

- Please keep all information for future reference.
- The declaration of conformity may be consulted at <http://doc.casio.com/>
- Products are for distribution within all member states of the EU.

For Europe models are SR-S4000MB-SR SR-S4000MD-SR, (SR-S4000MK-SR, SR-S4000MG-SR).

Maximum radio output power

- Bluetooth: 2.4GHz \leq 0dBm.

Laite on liitettävä suojamaadoituskostkeittimillä vaurstettuun pistorasiaan
Apparatet må tilkoples jordet stikkontakt
Apparaten skall anslutas till jordat nätuttag.

This product is also designed for IT power distribution system with phase-to-phase voltage 230 V.

WARNING

THIS IS A CLASS A PRODUCT. IN A DOMESTIC ENVIRONMENT THIS PRODUCT MAY CAUSE RADIO INTERFERENCE IN WHICH CASE THE USER MAY BE REQUIRED TO TAKE ADEQUATE MEASURES.

- [EN] Hereby, CASIO COMPUTER CO., LTD. declares that the radio equipment type SR-S4000 is in compliance with Directive 2014/53/EU. The full text of the EU declaration of conformity is available at the following internet address: <http://www.casio-europe.com>
- [DA] Hermed erklærer CASIO COMPUTER CO., LTD., at radioudstyrstypen SR-S4000 er i overensstemmelse med direktiv 2014/53/EU. EU-overensstemmelseserklæringens fulde tekst kan findes på følgende internetadresse: <http://www.casio-europe.com>
- [DE] Hiermit erkläre CASIO COMPUTER CO., LTD., dass der Funkanlagentyp SR-S4000 der Richtlinie 2014/53/EU entspricht. Der vollständige Text der EU-Konformitätserklärung ist unter der folgenden Internetadresse verfügbar: <http://www.casio-europe.com>
- [ES] Por la presente, CASIO COMPUTER CO., LTD., declara que el tipo de equipo radioeléctrico SR-S4000 es conforme con la Directiva 2014/53/UE. El texto completo de la declaración UE de conformidad está disponible en la dirección Internet siguiente: <http://www.casio-europe.com>
- [FR] Le soussigné, CASIO COMPUTER CO.,LTD., déclare que l'équipement radioélectrique du type SR-S4000 est conforme à la directive 2014/53/UE. Le texte complet de la déclaration UE de conformité est disponible à l'adresse internet suivante: <http://www.casio-europe.com>
- [NL] Hierbij verklaar ik, CASIO COMPUTER CO.,LTD., dat het type radioapparatuur SR-S4000 conform is met Richtlijn 2014/53/EU. De volledige tekst van de EU-conformiteitsverklaring kan worden geraadpleegd op het volgende internetadres: <http://www.casio-europe.com>
- [PT] O(a) abaixo assinado(a) CASIO COMPUTER CO.,LTD. declara que o presente tipo de equipamento de rádio SR-S4000 está em conformidade com a Diretiva 2014/53/UE. O texto integral da declaração de conformidade está disponível no seguinte endereço de Internet: <http://www.casio-europe.com>
- [FI] CASIO COMPUTER CO.,LTD. vakuuttaa, että radiolaitetyyppi SR-S4000 on direktiivin 2014/53/EU mukainen. EU-vaatimustenmukaisuusvakuutuksen täysimittainen teksti on saatavilla seuraavassa internetosoitteessa: <http://www.casio-europe.com>
- [SV] Härmed försäkras CASIO COMPUTER CO.,LTD. att denna typ av radioutrustning SR-S4000 överensstämmer med direktiv 2014/53/EU. Den fullständiga texten till EU-försäkran om överensstämmelse finns på följande webbadress: <http://www.casio-europe.com>

To use the cash register's basic function

Getting started	E-12
Name of Parts	E-12
Loading memory protection batteries.....	E-13
Installing paper roll	E-14
To set the language (country), date, time, tax rates and Bluetooth pairing	E-16
Getting to know your cash register	E-18
To adjust the main display	E-19
To set the customer display	E-19
Display	E-20
Keyboard	E-21
How to read the printouts	E-23
How to use your cash register	E-24
Checking the time and date.....	E-25
Preparing bills and coins for change	E-25
Before opening your store	E-25
Registering items in departments	E-26
Basic setups and registrations	E-29
To program basic settings.....	E-29
Programming departments	E-32
Registering departments' preset data.....	E-33
Programming PLUs	E-34
Registering PLUs' preset data.....	E-35
Other registrations	E-37
Discount	E-37
Reduction	E-38
Registering various payment methods	E-39
Registering returned goods	E-41
Registrations without transactions	E-43
Corrections	E-44
Daily sales reports	E-48
Print out of daily sales report.....	E-49

To use the cash register's basic function

Getting started

This chapter shows how to setup the cash register and get it ready to operate.

Name of Parts

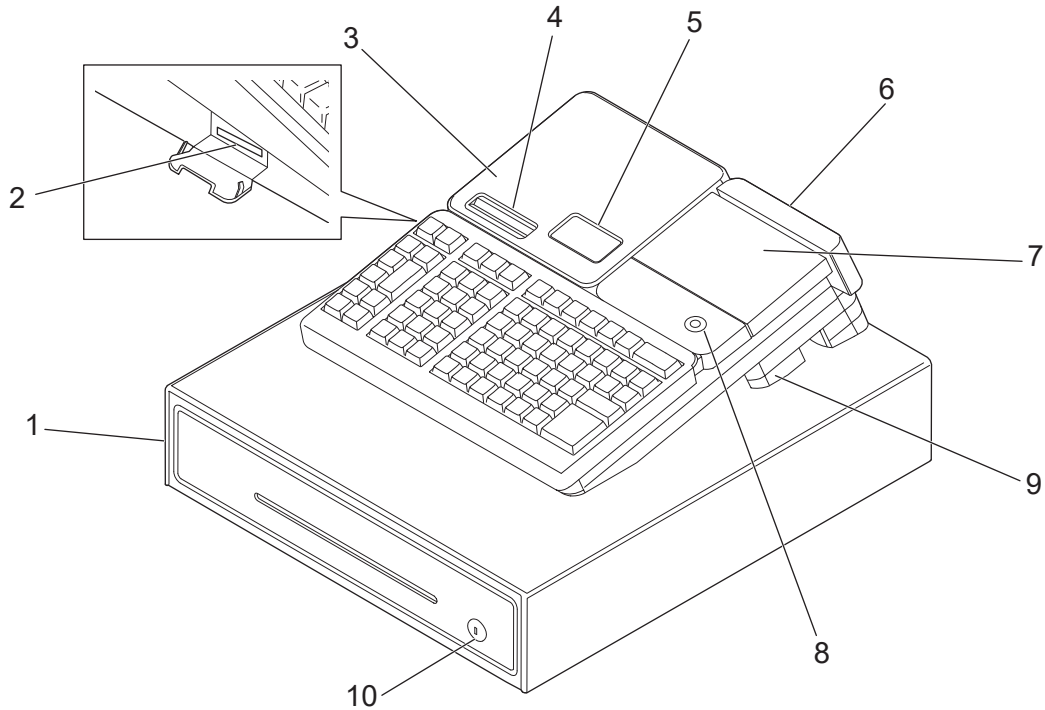

- | | | | |
|---|--------------------|----|--------------------------|
| 1 | Drawer | 6 | Customer display |
| 2 | SD card slot cover | 7 | Main display |
| 3 | Printer cover | 8 | Mode switch |
| 4 | Receipt printer | 9 | COM port connector cover |
| 5 | Journal printer | 10 | Drawer lock |

To use the cash register's basic function

Loading memory protection batteries

Important: These batteries protect information stored in your cash register's memory when there is a power failure or when you unplug the cash register. Be sure to install these batteries first.

1 Remove the printer cover.

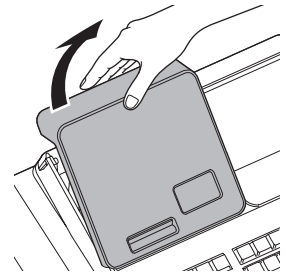

2 Remove the battery compartment cover.

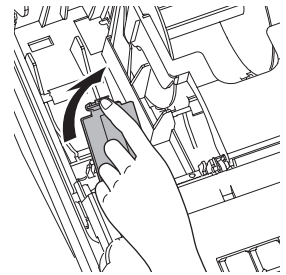

3 Note the (+) and (-) markings in the battery compartment. Load a set of two new "AA" type alkaline batteries so that their plus (+) and minus (-) ends are facing as indicated by the markings.

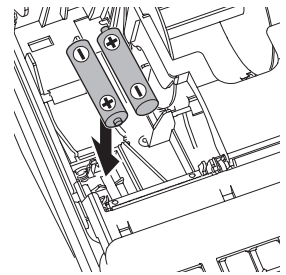

4 Replace the battery compartment cover and the printer cover.

Warning

- No battery is included in the accessories.
- Never try to recharge the batteries.
- Do not expose batteries to direct heat, let them become shorted or try to take them apart.
- Keep batteries out of the reach of small children. If your child should swallow a battery, consult a physician immediately.
- There is a risk of explosion if the batteries are replaced with improper type.
- Dispose of used batteries according to the instructions.

To use the cash register's basic function

Installing paper roll

Caution (in handling the thermal paper)

- Never touch the printer head and the platen.
- Unpack the thermal paper just before your use.
- Avoid heat and direct sunlight.
- Avoid dusty and humid places for storage.
- Do not scratch the paper.
- Do not keep the printed paper under the following circumstances:
 - High humidity and temperature/direct sunlight/contact with glue, thinner or a rubber eraser.

■ To install receipt paper

- 1** Remove the printer cover.
- 2** Open the platen arm of the receipt printer (on the left) by lifting it up.
- 3** Ensuring the paper is being fed from the bottom of the roll, lower the roll into the space behind the printer.
- 4** Put the leading end of the paper over the printer.
- 5** Close the platen arm slowly until it locks securely. Please push the position marked [PUSH HERE].
- 6** Replace the printer cover, passing the leading end of the paper through the cutter slot. Tear off the excess paper.

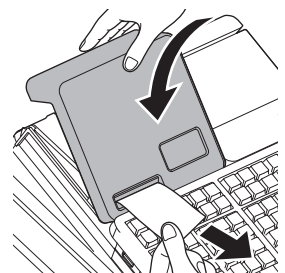
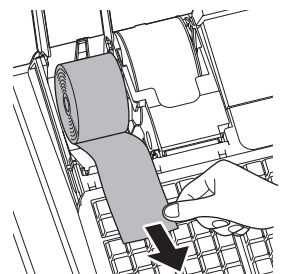
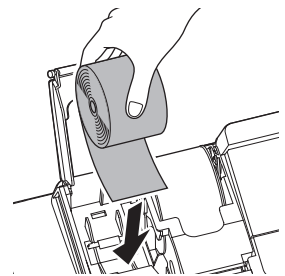
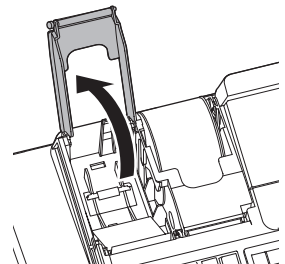

To use the cash register's basic function

■ To install journal paper

1 By the same procedure of setting receipt paper, set journal paper on the journal printer.

2 Remove the paper guide of the take-up reel.

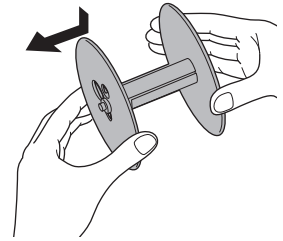

3 Slide the leading end of the paper into the groove on the spindle of the take-up reel and wind it onto the reel two or three turns.

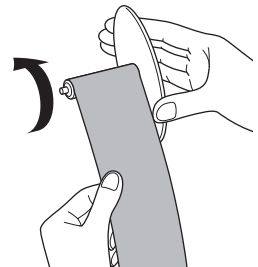
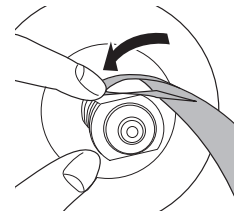

4 Replace the paper guide of the take-up reel.

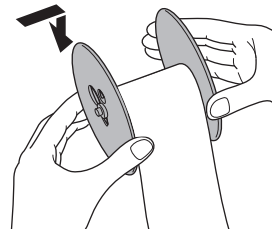

5 Place the take-up reel into place behind the printer, above the roll paper.

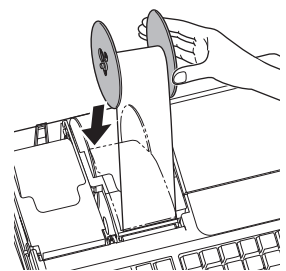

To use the cash register's basic function

To set the language (country), date, time, tax rates and Bluetooth pairing

1 Plug in the power socket into a wall outlet.

Be sure to check the rating plate on the side of the cash register to make sure that its voltage matches that of the power supply in your area.

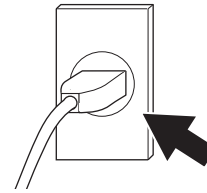

2 As soon as the power socket is plugged in, the display shows the language selection display. Choose language and country by using Δ or ∇ keys then press

$\boxed{\text{CA/AMT/TEND}}$ key.

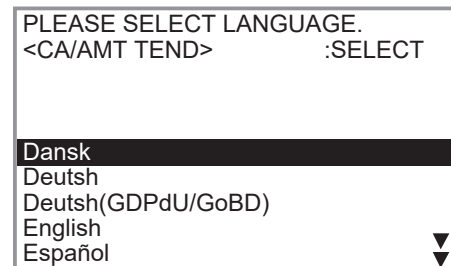

NOTE

- Actual display shows characters in white on blue background.
- Selectable languages and countries depend on the cash register model.

3 Display changes to date and time setting display. Moving the input area (reversed area) by Δ or ∇ keys, input date, month, year and time from ten key pad.

Input the time by 24 - hour system. For example, 1356 for 1:56 pm. After then press $\boxed{\text{CA/AMT/TEND}}$ key.

Depending on the language and country you selected, the cash register may asks if you use tax system/GST or rounding system. Please follow the instructions shown on the display.

The followings are operation examples for inputting tax rates.

4 Display then changes to tax table setting screen. Using ten key pad, input tax rates. You can set four kinds of tax rates.

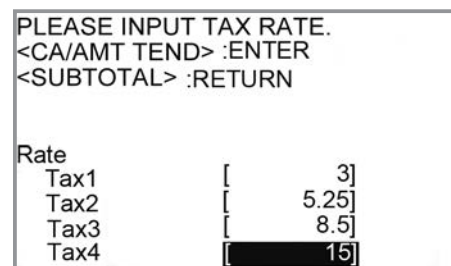
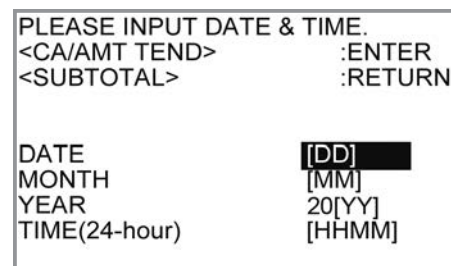

5 Press $\boxed{\text{CA/AMT/TEND}}$ key. Replace the printer cover.

To use the cash register's basic function

- 6** Using a smartphone application, you can perform cash register settings by pairing with a smartphone via Bluetooth connection.

If you wish to use the smartphone application, select [YES] and pair with a smartphone. If you do not wish to pair with a smartphone via Bluetooth connection, select [NO]. You can pair with a smartphone and use the application later on in PGM mode.

The followings are the procedures when you select [YES].

- 7** Activate Bluetooth on your smartphone. On the smartphone, find and select the device code of the cash register shown on the display. In this example, 12345678901234.

Note that the device code differs depending on each cash register. Make sure to select the same code shown on the cash register display.

- 8** After you select the device code on the smartphone, the cash register then shows a pass key on the display. Enter the pass key (in this example, 123456) on the smartphone. Pass key differs depending on each cash register.

- 9** Now your cash register and your smartphone are paired by Bluetooth connection.

Do you want to connect mobile via Bluetooth? <CA/AMT TEND>	:ENTER
[YES]	
[NO]	

Activate Bluetooth on mobile and select below device on the mobile. <SUBTOTAL>	:CANCEL
12345678901234	

Enter pass key on your mobile. <SUBTOTAL>	:CANCEL
123456	

You can perform detail settings or data exchange using Bluetooth connection. Please refer to the website <http://web.casio.com/ecr/app/>.



To use the cash register's basic function

Getting to know your cash register

Mode switch

Use the mode keys to change the position of the mode switch and select the mode you want to use.

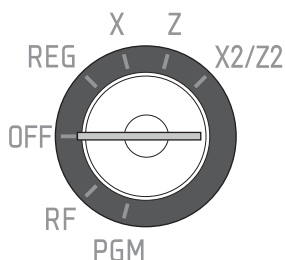

PGM (Programming)

This position is for setting your cash register to suit the needs of your store.

RF (Refund)

Use this position to correct registered items.

OFF

The cash register turns off in this position.

REG (Register)

This position is for normal transactions.

X (Read)

This is the position used for issuing daily sales totals report without clearing the data.

Z (Reset)

This position is for issuing reports of daily totals with clearing the accumulated totals.

X2/Z2 (Periodic sale read/reset)

Used to obtain periodic sales reports without resetting total data.

Mode keys

There are two types of mode keys: the program key (marked "PGM") and the operator key (marked "OP"). The program key can be used to set the mode switch to any position, while the operator key can select the REG and OFF position.

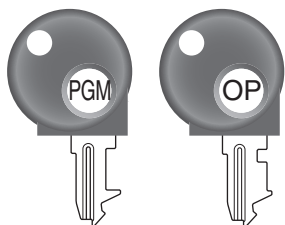

	PGM	RF	OFF	REG	X	Z	X2/Z2
OP key	-	-	○	○	-	-	-
PGM key	○	○	○	○	○	○	○

Drawer

The drawer opens automatically whenever you finalize a registration and whenever you issue a read or reset report. The drawer will not open if it is locked with the drawer key.

Drawer key

Use this key to lock and unlock the drawer.

Magnetic plate

Use this plate for tacking the notes received from customer.

To use the cash register's basic function

To adjust the main display

- 1 Put in fingers in the ditch of the main display and tilt it to the angle you can see clearly.

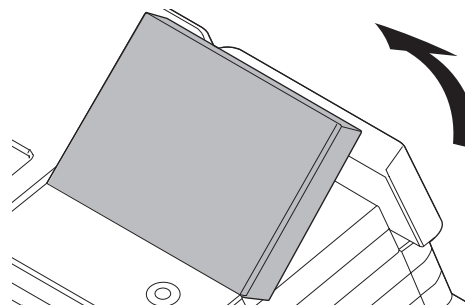

To set the customer display

- 1 Lift the customer display until it stops.

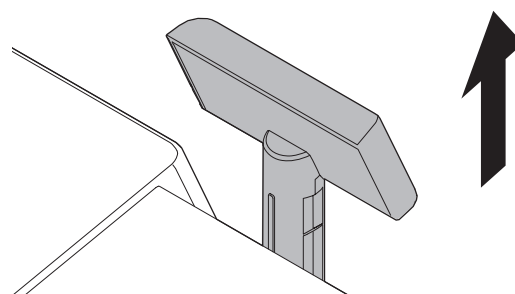

- 2 Rotate the display so that customers can see it.

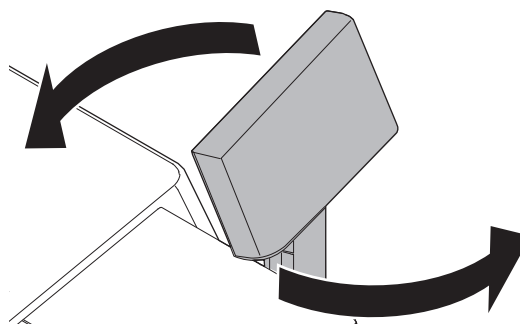

To use the cash register's basic function

Display

NOTE Actual display shows characters in white on blue background.

■ Main display

During a registration

C01	REG	000004	1
1	PLU001	•1.00	2
3	DEPT001	•6.00	
SUBTOTAL		•7.00	3
4	QT	6.00	4

After finalization

C01	REG	000004	
1	PLU001	•1.00	
3	DEPT001	•6.00	
	TL	•7.00	5
	CASH	•10.00	6
	CG	•3.00	7
CG		•3.00	8
4	QT	•10.00	9

- | | |
|---|----------------------------------|
| 1 Clerk Number or name/Mode/Consecutive No. | 5 Total amount |
| 2 Registered item Quantity/Category/Price | 6 Paid by/Tendered amount |
| 3 Subtotal amount | 7 Change |
| 4 Total quantity/Price of the last item | 8 Change |
| | 9 Total quantity/Tendered amount |









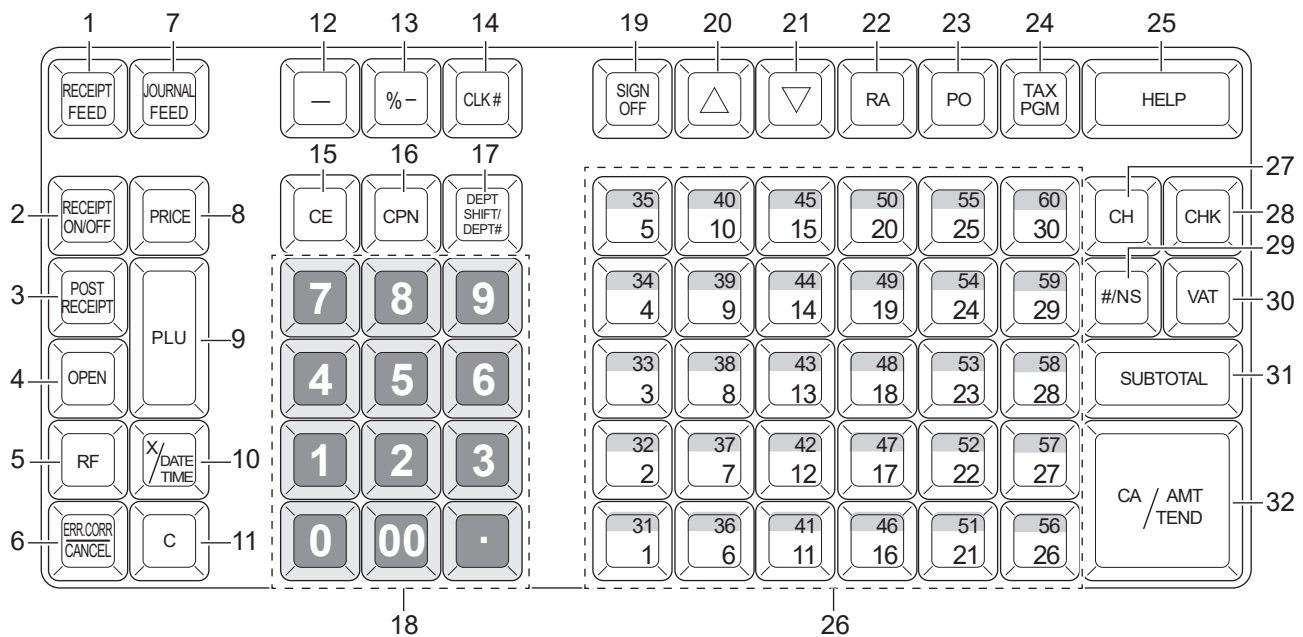









■ Customer display

















To use the cash register's basic function

Keyboard



- 1  Hold this key down to feed receipt paper from the printer.
- 2  Use this key to switch issuing receipts on and off.
- 3  Use this key to issue a post-finalization receipt.
- 4  Use this key to temporarily release a limitation on the number of digits for a unit price.
- 5  Use this key to input refunded amounts or to void preceding inputs.
- 6  Use this key to correct a registration error or to cancel a transaction.
- 7  Hold this key down to feed journal paper from the printer.
- 8  Use this key to register unit prices for a PLU (subdepartment).
- 9  Use this key to input PLU (subdepartment) numbers.
- 10  Use this key to input a quantity for a multiplication. Between transactions, pressing this key displays the current time and date.
- 11  Use this key to clear an entry that has not yet been registered.
- 12  Use this key to input reduction values.
- 13  Use this key to register discounts.
- 14  Use this key to input a clerk number.
- 15  Use this key for calculating subtotal amounts or paying amount due in foreign currency.
- 16  Use this key to register coupons.
- 17  Department no. Use this key to input department numbers. Department shift: Use this key to shift the department number from 1 through 30 to 31 through 60.
- 18  Use these keys to input numbers.

To use the cash register's basic function

- 19  Use this key to sign clerk off the register.
- 20  Use this key to move the cursor on the display up.
- 21  Use this key to move the cursor on the display down.
- 22  Use this key following a numeric entry to register money received for non-sale transactions.
- 23  Use this key following a numeric entry to register money paid out from the drawer.
- 24  Use this key to set the tax status and tax table.
- 25  Use this key to look up the procedures to set date/time, tax table etc.
- 26  to  Use these keys to register items to departments.
- 27  Use this key to register a charge sale.
- 28  Use this key to register a check tendering.
- 29  Non-add key: Use this key to print reference number (to identify a personal check, credit card, etc.) during a transaction. Use this function after a numeral entry. No sale key: Use this key to open the drawer without any registration.
- 30  Use this key to print a VAT breakdown.
- 31  Use this key to display and print the current subtotal (including tax) amount.
- 32  Use this key to register a cash sale.

To use the cash register's basic function

How to read the printouts

- The journal/receipts are records of all transactions and operations.
- The contents printed on receipts and journal are almost identical.
- You can choose the journal skip function.
If the journal skip function is selected, the cash register will print the total amount of each transaction, and the details of premium, discount and reduction operations only, without printing department and PLU item registrations on the journal.
- The following items can be skipped on receipts and journal.
 - Taxable status
 - Taxable amount
 - Item counter

Receipt Sample

```

*****
* THANK YOU *
** CALL AGAIN **
*****

* COMMERCIAL MESSAGE *
* COMMERCIAL MESSAGE *
* COMMERCIAL MESSAGE *
* COMMERCIAL MESSAGE *

REG 20-06-2018 11:58
C01 0001 000123

1 DEPT001 T1 -1.00
1 DEPT002 T1 -2.00
5 DEPT003 -5.00
7 No
TA1 -3.00
TX1 -0.15
TL -8.15
CASH -10.00
CG -1.85

*** BOTTOM MESSAGE ***
*** BOTTOM MESSAGE ***
*** BOTTOM MESSAGE ***
*** BOTTOM MESSAGE ***
    
```

Journal Sample (with items)

```

REG 20-06-2018 11:58
C01 0001 000123
1 DEPT001 T1 -1.00
1 DEPT002 T1 -2.00
5 DEPT003 -5.00
7 No
TA1 -3.00
TX1 -0.15
TL -8.15
CASH -10.00
CG -1.85

REG 20-06-2018 11:59
C01 0001 000124
1 DEPT001 T1 -1.00
1 DEPT012 T1 -1.00
5 DEPT003 -6.00
7 No
TA1 -2.00
TX1 -0.10
TL -8.10
CASH -10.00
CG -1.90

REG 20-06-2018 11:59
C01 0001 000124
    
```

Journal Sample (by half height character)

```

REG 20-06-2018 11:58
C01 0001 000123
1 DEPT001 T1 -1.00
1 DEPT002 T1 -2.00
5 DEPT003 -5.00
7 No
TA1 -3.00
TX1 -0.15
TL -8.15
CASH -10.00
CG -1.85

REG 20-06-2018 11:59
C01 0001 000124
1 DEPT001 T1 -1.00
1 DEPT012 T1 -1.00
5 DEPT003 -6.00
7 No
TA1 -2.00
TX1 -0.10
TL -8.10
CASH -10.00
CG -1.90

REG 20-06-2018 11:59
C01 0001 000125
    
```

- | | |
|-------------------------------------|--------------------------------|
| 1 Logo message* ¹ | 5 Q'ty/Item |
| 2 Commercial message* ¹ | 6 Item counter |
| 3 Mode/Date/Time | 7 Bottom message* ¹ |
| 4 Clerk/Machine No./Consecutive No. | |

In the operation examples in this manual, the printout samples are what would be printed.

* 1 To set for printing those messages, please see page E-82 "Set code 21".

To use the cash register's basic function

How to use your cash register

The following describes the general procedure you should use in order to get the most out of your cash register.

Before opening your store

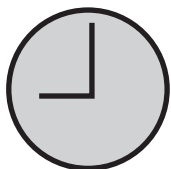

- Plugged in? (page E-16)
- Enough paper roll? (pages E-14 and E-15)
- Date and time are correct? (pages E-25 and E-30)
- Enough small change in the drawer? (page E-25)



While the store is open



- Registrations (page E-26)
- Issuing latest total sales report if needed. (page E-48)



After closing the store



- Issuing day's total sales report. (page E-48)
- Withdraw the money from the drawer.
After you withdraw all the money from the drawer, we recommend that you leave the drawer open when you leave your store. (page E-25)
- Turn the Mode switch to OFF. (page E-18)

To use the cash register's basic function

Before opening your store

Checking the time and date

You can check the time or date on the display whenever there is no registration being made.

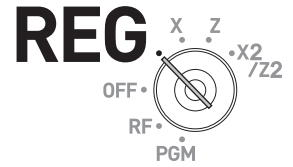

Step	Operation	Display
1 Press key to show the date and time on the display.		
2 Press key to clear the date/time display.		

Preparing bills and coins for change

To prepare coins and bills for change, you can open the drawer by pressing key. This operation must be performed when registrations are not being made.

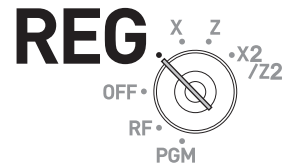

NOTE Opening the drawer by key does not perform any calculation in the register. If you wish to obtain a report that tells you the total amount in drawer, use key instead of key. See page E-43.

Step	Operation	Printout
1 Press . The cash drawer opens.		
2 Prepare coins and bills in the drawer.		

To use the cash register's basic function

Registering items in departments

The following examples show how you can use the department keys in various types of registrations.

Departments are used for categorizing items for example, department 01 for vegetables, department 02 for fruits, and department 03 for canned foods etc.

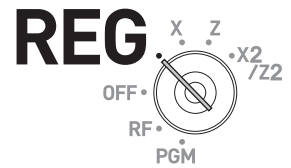

■ Single item sale

Sample Operation

Item	Unit Price	•1.00	One •1.00 Dept. 01 item is sold and the customer paid the same amount as the total amount.
	Quantity	1	
	Dept.	01	
Payment	Cash	•1.00	

Step	Operation	Printout						
1 Enter the unit price.	1 00	<table border="1"> <tr> <td>1 DEPT001</td> <td>• 1.00</td> </tr> <tr> <td>TL</td> <td>- 1.00</td> </tr> <tr> <td>CASH</td> <td>• 1.00</td> </tr> </table>	1 DEPT001	• 1.00	TL	- 1.00	CASH	• 1.00
1 DEPT001	• 1.00							
TL	- 1.00							
CASH	• 1.00							
2 Press corresponding department key.	1							
3 Press CA / AMT / TEND key.	CA / AMT / TEND							

Further operations:

• For simpler operation of single item sales, see page E-55 “Single item cash sales”.

■ Single item sales with change calculation

Sample Operation

Item	Unit Price	•12.34	One item is sold and the customer paid more than the total amount.
	Quantity	1	
	Dept.	01	
Payment	Cash	•20.00	

Step	Operation	Printout								
1 Enter the unit price.	1 2 3 4	<table border="1"> <tr> <td>1 DEPT001</td> <td>• 12.34</td> </tr> <tr> <td>TL</td> <td>- 12.34</td> </tr> <tr> <td>CASH</td> <td>• 20.00</td> </tr> <tr> <td>CG</td> <td>• 7.66</td> </tr> </table>	1 DEPT001	• 12.34	TL	- 12.34	CASH	• 20.00	CG	• 7.66
1 DEPT001	• 12.34									
TL	- 12.34									
CASH	• 20.00									
CG	• 7.66									
2 Press corresponding department key.	1									
3 Press SUB TOTAL key.	SUB TOTAL									
4 Enter the tendered amount then press CA / AMT / TEND key. The display shows the change to be paid.	2 0 00 CA / AMT / TEND									

To use the cash register's basic function

Repeat registration

Sample Operation

Item	Unit Price	•1.50	Same priced multiple items are sold.
	Quantity	3	
	Dept.	1	
Payment	Cash	•10.00	

Step	Operation	Printout												
1 Enter the unit price.	1 5 0	<table border="1"> <tr><td>1 DEPT001</td><td>· 1.50</td></tr> <tr><td>1 DEPT001</td><td>· 1.50</td></tr> <tr><td>1 DEPT001</td><td>· 1.50</td></tr> <tr><td>TL</td><td>- 4.50</td></tr> <tr><td>CASH</td><td>· 10.00</td></tr> <tr><td>CG</td><td>· 5.50</td></tr> </table>	1 DEPT001	· 1.50	1 DEPT001	· 1.50	1 DEPT001	· 1.50	TL	- 4.50	CASH	· 10.00	CG	· 5.50
1 DEPT001	· 1.50													
1 DEPT001	· 1.50													
1 DEPT001	· 1.50													
TL	- 4.50													
CASH	· 10.00													
CG	· 5.50													
2 Press corresponding department key repeatedly for the purchased quantity.	1 1 1													
3 Press SUB TOTAL key.	SUB TOTAL													
4 Enter the tendered amount then press CA / AMT / TEND key. The display shows the change to be paid.	1 0 00 CA / AMT / TEND													

Multiple items registration using multiplication key

Sample Operation

Item	Unit Price	•1.00	Twelve pieces of •1.00 item are sold and the customer paid more than the total amount.
	Quantity	12	
	Dept.	1	
Payment	Cash	•20.00	

Step	Operation	Printout								
1 Enter the quantity then press × / DATE TIME key.	1 2 × / DATE TIME	<table border="1"> <tr><td>12 DEPT001</td><td>· 12.00</td></tr> <tr><td>TL</td><td>- 12.00</td></tr> <tr><td>CASH</td><td>· 20.00</td></tr> <tr><td>CG</td><td>· 8.00</td></tr> </table>	12 DEPT001	· 12.00	TL	- 12.00	CASH	· 20.00	CG	· 8.00
12 DEPT001	· 12.00									
TL	- 12.00									
CASH	· 20.00									
CG	· 8.00									
2 Enter the unit price and press corresponding department key.	1 00 1									
3 Press SUB TOTAL key.	SUB TOTAL									
4 Enter the tendered amount then press CA / AMT / TEND key. The display shows the change to be paid.	2 0 00 CA / AMT / TEND									







To use the cash register's basic function

■ Department shift

By using  , Dept. 01 through 30 are assigned to Dept. 31 through 60.

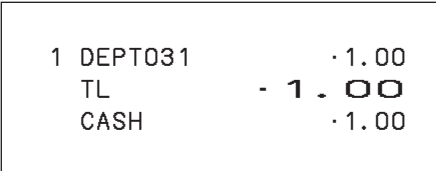
Sample Operation

Item	Unit Price	•1.00	Department 31 is assigned by using  key.
	Quantity	1	
	Dept.	31	
Payment	Cash	•1.00	









Step	Operation	Printout
1 Press  key. “SHIFT/No” will be shown at the bottom of the display.		
2 Enter the unit price and press corresponding department key. Then press  key. The item is registered in Dept. 31 in this example.		
3 Press  key to finalize the transaction.		

■ Department number entry

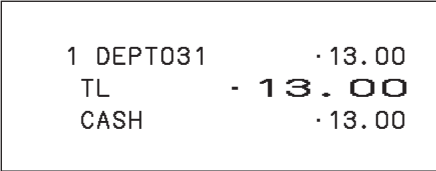
Without using Department key, you can register departments manually.

Sample Operation

Item	Unit Price	•13.00	Registering an item in Dept. 31 without using Department key.
	Quantity	1	
	Dept.	31	
Payment	Cash	•13.00	

Step	Operation	Printout
1 Enter Dept. number using ten key pad then press  key.		
2 Enter the unit price and press  key. Then press  key. The item is registered in Dept. 31 in this example.		
3 Press  key to finalize the transaction.		

To use the cash register's basic function

Basic setups and registrations

To program basic settings

You can program basic settings in the PGM mode of the Mode switch.

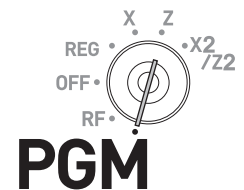

Step

Display

- 1 By turning the Mode switch to PGM position, the display indicates the programming top menu.
- 2 Use or keys to choose the item you wish to set then press key.
Repeat the above step until the display shows an entry display.
- 3 Input values you wish to set and press key.

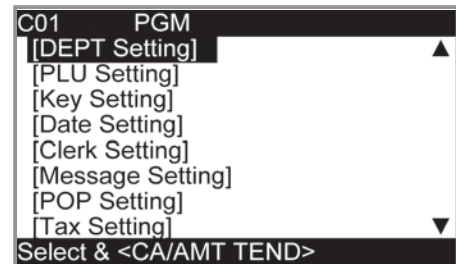

The following table shows the setting items of the basic programming.

■ Program menus

Top menu	Sub menu	What is to be set	
[DEPT Setting]	DEPT name [DEPT001]	Sets name, unit price, taxable status, item group and high amount limitation in each department. See page E-32.	
	Unit Price [0.00]		
	Taxable Status [NON TAX]		
	Group Link [00]		
	High AMT Limit [0.00]		
	POP No. []		
	Advanced		Single Item [NO]
[PLU Setting]	PLU name [PLU0001]	Sets name, unit price, taxable status, item group, department link and open PLU in each PLU. See page E-34.	
	Unit Price [0.00]		
	Taxable Status [NON TAX]		
	Group Link [00]		
	DEPT Link [000]		
	Open PLU [NO]		
	Advanced		0 Unit Price [NO]
			Negative Price [NO]
			Min Stock [0]
			OBR Code [00000000000000]

To use the cash register's basic function

Top menu	Sub menu	What is to be set	
[Key Setting]	CE	Sets name, taxable status, and whether to use taxable status or not in each function key.	
	%-		
	-		
	COUPON		
[Date Setting]	TIME (24 HOUR) [19:56]	Sets date and time.	
	DATE [26]		
	MONTH [12]		
	YEAR 20[18]		
[Clerk Setting]	Secret No [0001]		
	Operation [YES]		
[Message Setting]	01 Logo 1	YOUR RECEIPT	Please refer to pages E-23 and E-82.
	02 Logo 2	THANK YOU	
	03 Logo 3	CALL AGAIN	
	04 Logo 4		
	05 Commercial 1		
	06 Commercial 2		
	07 Commercial 3		
	08 Commercial 4		
	09 Bottom 1		
	10 Bottom 2		
	11 Bottom 3		
	12 Bottom 4		
[POP Setting]	Read POP Data		Please refer to page E-116.
	POP Operation Setting		
	Print POP image		
[Tax Setting]	RATE		Depending on the model and selected language (country), number of tax (Tax 1 - Tax 3, Tax 1 - Tax 4, Tax 1 - Tax 10 etc.) differ.
	ROUND		
	CAL TYPE		
[General Setting]	Enable clerk [NO]		Sets general controls of the register such as clerk assignment, printing journal in half size etc.
	Journal 1/2 Print [YES]		
	Consecutive No. Reset [YES]		
	EJ clear (After Daily Z) [YES]		
	EJ/Sales→SD (After XZ) [NO]		
	Prohibit Reg(Stock < 0) [NO]		
[Water Mark Setting]	Min Stock Alert [NO]		
	YES		
	NO		
[SD card]	Backup → SD		Exchanges sales data, program data, and receipt's message data between the register and an SD card. See page E-113.
	Restore← SD		
	Program→ SD		
	Program← SD		
	SD Format		
	Backup → Flash		
	AutoProgram→ SD		
	AutoProgram← SD		

To use the cash register's basic function

Top menu	Sub menu	What is to be set
[Bluetooth]	System Setting	See page E-111.
	Functions	If you wish to perform further settings using a smartphone, please refer to page E-111.
[System Setting]		Used to set characters, functions of keys, or calculation methods etc.

To use the cash register's basic function

Programming departments

This section explains how you can set unit prices, taxable statuses, and item groups. You can program each department linking to a certain group. For example, department 01 is for packed milk, department 02 is for cheese and both belong to group 03 (dairy goods).

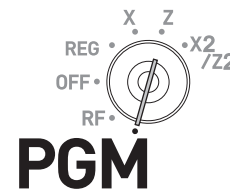

Sample Operation

Dept. 01	Unit Price	•2.50	Programming Dept. 01 as unit price •2.50, non taxable, belonging to Group 02.
	Taxable status	Non tax	
	Group	02	

Step

1 Turn the Mode switch to PGM position. The display shows the top screen of programming.

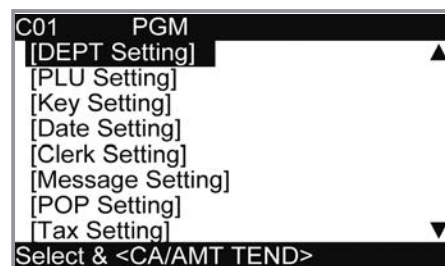

2 Using Δ or ∇ keys, select [DEPT Setting] then press CA/AMT/TEND key. The display shows [DEPT Setting] screen.

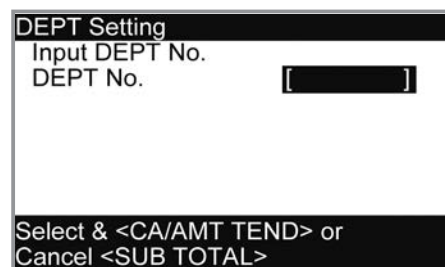

3 Enter the department number (01 in this example) then press CA/AMT/TEND key. The display shows department selection screen. You can change the department by using Δ or ∇ keys.

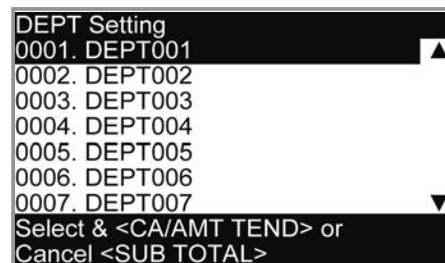

4 Press CA/AMT/TEND key. The display shows program input screen. Input unit price and group link you wish to program. The top column is for setting characters to the dept. You can leave the column empty. If you wish to set characters now, please see page E-64.

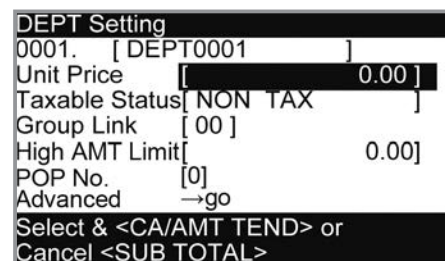

5 Select [Taxable Status] and press CA/AMT/TEND key. The display shows taxable status selection screen. Choose the taxable status and press CA/AMT/TEND key.

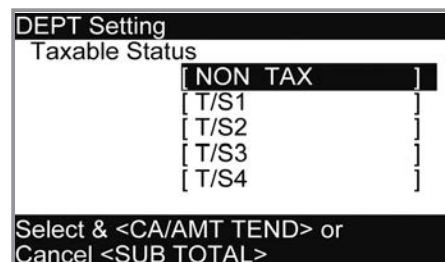

NOTE The display returns to the previous screen by pressing SUB TOTAL key.

To use the cash register's basic function

Registering departments' preset data

The following examples explain the operations using preset department data programmed in the previous section.



■ Using preset prices

Sample Operation

Item	Unit Price	•2.50	Unit price •2.50 is preset in Dept. 02.
	Quantity	1	
	Dept.	02	
Payment	Cash	•2.50	

Step	Operation	Printout									
1 Just press the corresponding Department key.	<input type="text" value="2"/>	<table border="1"> <tr> <td>1 DEPT002</td> <td></td> <td>•2.50</td> </tr> <tr> <td>TL</td> <td>-</td> <td>2.50</td> </tr> <tr> <td>CASH</td> <td></td> <td>•2.50</td> </tr> </table>	1 DEPT002		•2.50	TL	-	2.50	CASH		•2.50
1 DEPT002			•2.50								
TL	-	2.50									
CASH		•2.50									
2 Press <input type="text" value="CA/AMT/TEND"/> key to finalize the transaction.	<input type="text" value="CA/AMT/TEND"/>										

■ Using preset tax statuses

Sample Operation

Item 1	Unit Price	•2.00	<ul style="list-style-type: none"> • Dept. 03 presets: Unit price •2.00, Tax status 1 (4%). • Dept. 04 presets: Unit price •2.00, Tax status 2 (10%).
	Quantity	5	
	Dept.	03	
	Taxable	1	
Item 2	Unit Price	•2.00	
	Quantity	1	
	Dept.	04	
	Taxable	2	
Payment	Cash	•20.00	

Step	Operation	Printout																											
1 Register five pieces of Dept. 03 item using the multiplication key.	<input type="text" value="5"/> <input type="text" value="X/DATE TIME"/> <input type="text" value="3"/>	<table border="1"> <tr> <td>5 DEPT003</td> <td>T1</td> <td>•10.00</td> </tr> <tr> <td>1 DEPT004</td> <td>T2</td> <td>•2.00</td> </tr> <tr> <td>TA1</td> <td></td> <td>•10.00</td> </tr> <tr> <td>TX1</td> <td></td> <td>•0.40</td> </tr> <tr> <td>TA2</td> <td></td> <td>•2.00</td> </tr> <tr> <td>TX2</td> <td></td> <td>•0.20</td> </tr> <tr> <td>TL</td> <td>-</td> <td>12.60</td> </tr> <tr> <td>CASH</td> <td></td> <td>•20.00</td> </tr> <tr> <td>CG</td> <td></td> <td>•7.40</td> </tr> </table>	5 DEPT003	T1	•10.00	1 DEPT004	T2	•2.00	TA1		•10.00	TX1		•0.40	TA2		•2.00	TX2		•0.20	TL	-	12.60	CASH		•20.00	CG		•7.40
5 DEPT003	T1		•10.00																										
1 DEPT004	T2		•2.00																										
TA1			•10.00																										
TX1		•0.40																											
TA2		•2.00																											
TX2		•0.20																											
TL	-	12.60																											
CASH		•20.00																											
CG		•7.40																											
2 Press Dept. 04 key to register one •2.00 item.	<input type="text" value="4"/>																												
3 Press <input type="text" value="SUB TOTAL"/> key to indicate the total amount including tax.	<input type="text" value="SUB TOTAL"/>																												
4 Enter the tendered amount and press <input type="text" value="CA/AMT/TEND"/> key.	<input type="text" value="2"/> <input type="text" value="0"/> <input type="text" value="00"/> <input type="text" value="CA/AMT/TEND"/>																												

The above is a print example when [CAL TYPE] of Tax Setting is [ADD ON].

To use the cash register's basic function

Programming PLUs

Like departments, you can program unit price, taxable status, and linking item group in a PLU (Price Look Up). Using PLUs allow you to register items quickly and accurately. You can use up to 7,000 PLUs.

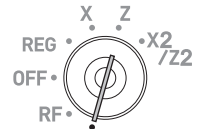

PGM

Sample Operation

PLU 0014	Unit Price	•2.50	Programming PLU 0014 as unit price •2.50, non taxable, belonging to Group 03.
	Taxable status	Non tax	
	Group	03	

Step

1 Turn the Mode switch to PGM position. The display shows the top screen of programming.

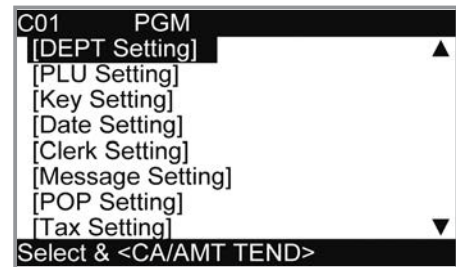

2 Using or keys, select [PLU Setting] then press key. The display shows [PLU Setting] screen.

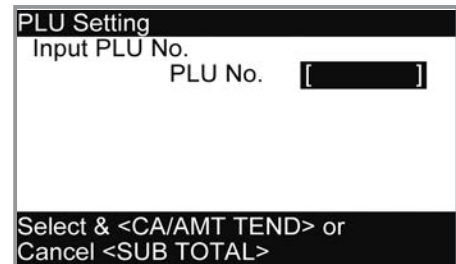

3 Enter the PLU number (0014 in this example) then press key. The display shows [PLU Setting] screen. You can change the PLU number by using or keys.

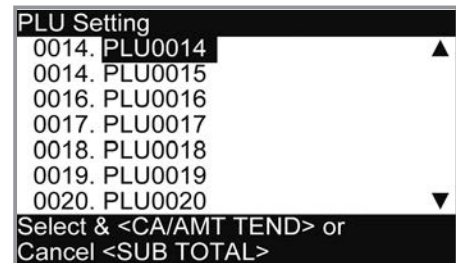

4 Press key. The display shows program input screen. Input unit price and group link you wish to program. The top column is for setting characters to the PLU. You can leave the column empty. If you wish to set characters now, please see page E-64.

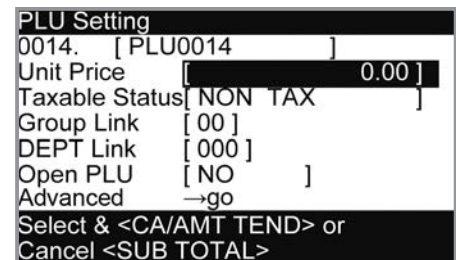

5 Select [Taxable Status] and press key. The display shows taxable status selection screen. Choose the taxable status and press key.

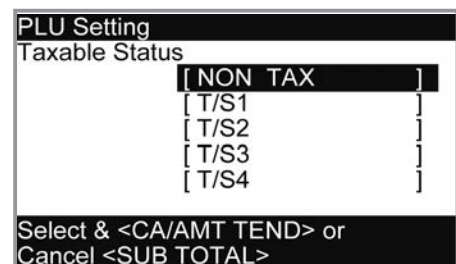

NOTE The display returns to the previous screen by pressing key.

To use the cash register's basic function

Registering PLUs' preset data

The following examples explain the operations using preset PLU data programmed in the previous section.

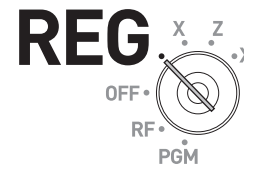

■ Single item sales using PLU

Sample Operation

Item	Unit Price	•2.50	One piece of PLU number 14 (preset unit price •2.50) is sold.
	Quantity	1	
	PLU No.	14	
Payment	Cash	•3.00	

Step	Operation	Printout								
1 Enter the PLU number and press <input type="button" value="PLU"/> key. One piece of PLU number 14 item has been registered. Then press <input type="button" value="SUB TOTAL"/> key.	1 4 <input type="button" value="PLU"/> <input type="button" value="SUB TOTAL"/>	<table border="1"> <tr> <td>1 PLU0014</td> <td>•2.50</td> </tr> <tr> <td>TL</td> <td>- 2.50</td> </tr> <tr> <td>CASH</td> <td>•3.00</td> </tr> <tr> <td>CG</td> <td>•0.50</td> </tr> </table>	1 PLU0014	•2.50	TL	- 2.50	CASH	•3.00	CG	•0.50
1 PLU0014	•2.50									
TL	- 2.50									
CASH	•3.00									
CG	•0.50									
2 Enter tendered amount and press <input type="button" value="CA / AMT / TEND"/> key.	3 00 <input type="button" value="CA / AMT / TEND"/>									

■ PLU repeat registration

Sample Operation

Item	Unit Price	•2.50	Three pieces of PLU number 14 (preset unit price •2.50) is sold.
	Quantity	3	
	PLU No.	14	
Payment	Cash	•10.00	







Step	Operation	Printout												
1 Enter the PLU number.	1 4	<table border="1"> <tr> <td>1 PLU0014</td> <td>•2.50</td> </tr> <tr> <td>1 PLU0014</td> <td>•2.50</td> </tr> <tr> <td>1 PLU0014</td> <td>•2.50</td> </tr> <tr> <td>TL</td> <td>- 7.50</td> </tr> <tr> <td>CASH</td> <td>•10.00</td> </tr> <tr> <td>CG</td> <td>•2.50</td> </tr> </table>	1 PLU0014	•2.50	1 PLU0014	•2.50	1 PLU0014	•2.50	TL	- 7.50	CASH	•10.00	CG	•2.50
1 PLU0014	•2.50													
1 PLU0014	•2.50													
1 PLU0014	•2.50													
TL	- 7.50													
CASH	•10.00													
CG	•2.50													
2 Press <input type="button" value="PLU"/> key repeatedly for the number of sold quantity. Three pieces of PLU 14 have been registered. Then press <input type="button" value="SUB TOTAL"/> key.	<input type="button" value="PLU"/> <input type="button" value="PLU"/> <input type="button" value="PLU"/> <input type="button" value="SUB TOTAL"/>													
3 Enter the tendered amount and press <input type="button" value="CA / AMT / TEND"/> key.	1 0 00 <input type="button" value="CA / AMT / TEND"/>													

To use the cash register's basic function

■ PLU registration with multiplication key

Sample Operation

Item	Unit Price	•2.00	Ten pieces of PLU number 7 item (preset unit price •2.00) are sold.
	Quantity	10	
	PLU No.	7	
Payment	Cash	•20.00	













Step	Operation	Printout								
1 Enter the quantity sold then press  key. Up to 9999.999 can be entered for multiplication calculations.		<div style="border: 1px solid black; padding: 5px;"> <table style="width: 100%; border-collapse: collapse;"> <tr> <td style="width: 60%;">10 PLU0007</td> <td style="text-align: right;">•20.00</td> </tr> <tr> <td>TL</td> <td style="text-align: right;">- 20.00</td> </tr> <tr> <td>CASH</td> <td style="text-align: right;">•20.00</td> </tr> <tr> <td>CG</td> <td style="text-align: right;">•0.00</td> </tr> </table> </div>	10 PLU0007	•20.00	TL	- 20.00	CASH	•20.00	CG	•0.00
10 PLU0007	•20.00									
TL	- 20.00									
CASH	•20.00									
CG	•0.00									
2 Enter the PLU number and press  key. Then press  key.										
3 Enter tendered amount and press  key.										

■ Open PLU

Although unit price is preset in a PLU, you can enter price manually if the PLU is programmed as “Open PLU”. To program open PLU, see page E-29.

Sample Operation

Item 1	Unit Price	•32.80	PLU numbers 30 and 31 are programmed as open PLU so that the unit prices can be entered manually.
	Quantity	1	
	PLU No.	30	
Item 2	Unit Price	•13.00	
	Quantity	2	
	PLU No.	31	
Payment	Cash	•60.00	

Step	Operation	Printout												
1 Enter the PLU number of the first item then press  key.		<div style="border: 1px solid black; padding: 5px;"> <table style="width: 100%; border-collapse: collapse;"> <tr> <td style="width: 60%;">1 PLU0030</td> <td style="text-align: right;">•32.80</td> </tr> <tr> <td>1 PLU0031</td> <td style="text-align: right;">•13.00</td> </tr> <tr> <td>1 PLU0031</td> <td style="text-align: right;">•13.00</td> </tr> <tr> <td>TL</td> <td style="text-align: right;">- 58.80</td> </tr> <tr> <td>CASH</td> <td style="text-align: right;">•60.00</td> </tr> <tr> <td>CG</td> <td style="text-align: right;">•1.20</td> </tr> </table> </div>	1 PLU0030	•32.80	1 PLU0031	•13.00	1 PLU0031	•13.00	TL	- 58.80	CASH	•60.00	CG	•1.20
1 PLU0030	•32.80													
1 PLU0031	•13.00													
1 PLU0031	•13.00													
TL	- 58.80													
CASH	•60.00													
CG	•1.20													
2 Enter the unit price and press  key.														
3 Enter the PLU number of the second item then press  key.														
4 Enter the unit price.														
5 Press  key repeatedly for the number of purchased quantity and press  key.														
6 Enter the tendered amount and press  key.														

To use the cash register's basic function

Other registrations

Discount

The following example shows how you can use the $\%-\text{}$ key for discount registrations.

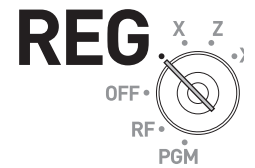

■ Discounts on items and subtotals

Sample Operation

Item 1	Dept. 01	•5.00	Five percent (preset in $\%-\text{}$ key) discount on PLU number 16 (preset unit price •10.00) and discount 3.5% on the subtotal amount.
	Quantity	1	
	Taxable	1 (preset)	
Item 2	PLU 16	•10.00 (preset)	
	Quantity	1	
	Taxable	2 (preset)	
Discount	Rate	5% (preset in $\%-\text{}$)	
	Subtotal discount	Rate	
Subtotal discount	Taxable	Non taxable (preset)	
	Payment	Cash	

Step	Operation	Printout
1	Enter the unit price and corresponding department key. 5 00 1	<pre> 1 DEPT001 T1 -5.00 1 PLU0016 T2 -10.00 5% %- T2 -0.50 SUBTOTAL -14.50 3.5% %- -0.51 TL -13.99 CASH 15.00 CG 1.01 </pre>
2	Enter the PLU number then press 1 6 PLU key. The preset unit price (•10.00) is registered.	
3	Press $\%-\text{}$ key. The discount amount with the preset rate (5%) is subtracted from the last item registered (PLU 16). $\%-\text{}$	
4	Press SUB TOTAL key for giving discount on the subtotal amount. SUB TOTAL	
5	Enter the discount rate manually and press 3 . 5 $\%-\text{}$ key. Discount amount with inputted rate is subtracted from the subtotal amount. 3 . 5 $\%-\text{}$	
6	Press SUB TOTAL key to show the total amount including tax and discounts. SUB TOTAL	
7	Enter the tendered amount and press 1 5 00 CA / AMT / TEND key. 1 5 00 CA / AMT / TEND	

Printout differs depending on preset tax statuses.

NOTE

- When you perform a discount operation on the last item registered, the tax of discount amount is calculated in accordance with the tax status programmed to the item.
- When you perform a discount operation on a subtotal amount, the tax of discount amount from subtotal is calculated in accordance with the tax status programmed in the $\%-\text{}$ key.
- To program discount rate in $\%-\text{}$ key, please see page E-30.

To use the cash register's basic function

Reduction

Using the reduction feature, you can subtract a certain amount from an item's unit price or from a subtotal amount.

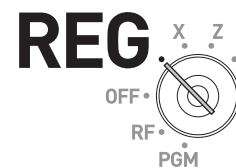

Sample Operation

Item 1	Dept. 01	•5.00	<ul style="list-style-type: none"> • Reducing •0.25 (manual input) from item 1 unit price. • Reducing •0.50 (preset amount) from item 2. • Reducing •0.75 (manual input) from subtotal amount.
	Quantity	1	
	Taxable	1 (preset)	
	Reduction	•0.25	
Item 2	PLU 45	•6.00 (preset)	
	Quantity	1	
	Taxable	1 (preset)	
	Reduction	•0.50 (preset)	
Subtotal	Reduction	•0.75	
	Taxable	Non taxable (preset)	
Payment	Cash	•10.00	

Step	Operation	Printout
1 Register item 1 by inputting the unit price and department key.	5 0 0 <input type="button" value="1"/>	<pre> 1 DEPT001 T1 ·5.00 - T1 -0.25 1 PLU0045 T1 ·6.00 - T1 -0.50 - -0.75 TL -9.50 CASH ·10.00 CG ·0.50 </pre>
2 Enter reduction amount manually and press <input type="button" value="-"/> key. •0.25 is subtracted from the unit price.	2 5 <input type="button" value="-"/>	
3 Register item 2 by inputting the PLU number and <input type="button" value="PLU"/> key.	4 5 <input type="button" value="PLU"/>	
4 Press <input type="button" value="-"/> key. Pressing <input type="button" value="-"/> key without numeral entry subtracts the preset reduction amount (•0.50 in this example) from the PLU's unit price.	<input type="button" value="-"/>	
5 Press <input type="button" value="SUB TOTAL"/> key for reducing amount from the subtotal.	<input type="button" value="SUB TOTAL"/>	
6 Enter reduction amount manually then press <input type="button" value="-"/> key. The inputted amount is subtracted from the subtotal amount.	7 5 <input type="button" value="-"/>	
7 Enter the tendered amount then press <input type="button" value="CA / AMT / TEND"/> key.	1 0 00 <input type="button" value="CA / AMT / TEND"/>	

Printout differs depending on preset tax statuses.

NOTE

- You can input up to seven digits reduction amount manually.
- To program preset reduction amount, please see page E-30.

To use the cash register's basic function

Registering various payment methods

Other than cash payments, you can register transactions made by checks, charges, credits, or even mixed tendering.

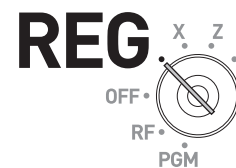

■ Check sale

Sample Operation

Item	Unit Price	•11.00	A •11.00 item is sold and customer paid by •20.00 check (check number 1234).
	Quantity	1	
Reference no. of check		1234	
Payment	Check	•20.00	

Step	Operation	Printout
1 Register the item purchased.	1 1 00 <input type="button" value="1"/>	<pre> 1 DEPT001 · 11.00 # 1234 TL - 11.00 CHECK · 20.00 CG · 9.00 </pre>
2 If you wish to record reference number such as a check number, enter the number then press <input type="button" value="#/NS"/> key.	1 2 3 4 <input type="button" value="#/NS"/>	
3 Enter the paid amount then press <input type="button" value="CHK"/> key.	2 0 00 <input type="button" value="CHK"/>	

■ Charge sale

Sample Operation

Item	Dept. 04	•15.00	A purchased item is transacted by charge sale.
	Quantity	1	
Payment	Charge	•15.00	

Step	Operation	Printout
1 Register the item purchased and press <input type="button" value="SUB TOTAL"/> key.	1 5 00 <input type="button" value="4"/> <input type="button" value="SUB TOTAL"/>	<pre> 1 DEPT004 · 15.00 TL - 15.00 CHARGE · 15.00 </pre>
2 Press <input type="button" value="CH"/> key to finalize the charge transaction.	<input type="button" value="CH"/>	

To use the cash register's basic function

■ Mixed payments (cash and check)

Sample Operation

Item	Dept. 04	•55.00	Customer paid •30.00 by check and the rest in cash for •55.00 item.
	Quantity	1	
Payment	Check	•30.00	
	Cash	•25.00	

Step	Operation	Printout										
1 Register the item purchased and press <input type="button" value="SUB TOTAL"/> key.	<input type="button" value="5"/> <input type="button" value="5"/> <input type="button" value="00"/> <input type="button" value="4"/> <input type="button" value="SUB TOTAL"/>	<table border="1"> <tr> <td>1 DEPT004</td> <td>·55.00</td> </tr> <tr> <td>TL</td> <td>- 55.00</td> </tr> <tr> <td>CHECK</td> <td>·30.00</td> </tr> <tr> <td>CASH</td> <td>·25.00</td> </tr> <tr> <td>CG</td> <td>·0.00</td> </tr> </table>	1 DEPT004	·55.00	TL	- 55.00	CHECK	·30.00	CASH	·25.00	CG	·0.00
1 DEPT004	·55.00											
TL	- 55.00											
CHECK	·30.00											
CASH	·25.00											
CG	·0.00											
2 Enter the amount paid by a check then press <input type="button" value="CHK"/> key.	<input type="button" value="3"/> <input type="button" value="0"/> <input type="button" value="00"/> <input type="button" value="CHK"/>											
3 Enter the paid cash amount then press <input type="button" value="CA / AMT / TEND"/> key.	<input type="button" value="2"/> <input type="button" value="5"/> <input type="button" value="00"/> <input type="button" value="CA / AMT / TEND"/>											

To use the cash register's basic function

Registering returned goods

■ Registering returned goods in the REG mode

The following example shows how to operate for registering goods returned by customer in the REG mode.

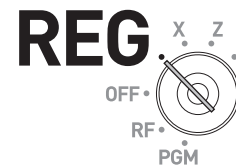

Sample Operation

Item 1	Dept. 01	•2.35	Customer returned items 1 and 3 during the registration.
	Quantity	1	
Item 2	Dept. 02	•2.00	
	Quantity	1	
Item 3	PLU 001	•1.20 (preset)	
	Quantity	1	
Refunded Item 1	Dept. 01	•2.35	
	Quantity	1	
Refunded Item 3	PLU 0001	•1.20 (preset)	
	Quantity	1	
Payment	Cash	•2.00	

Step	Operation	Printout
1 Register purchased item 1.	2 3 5 1	<pre> 1 DEPT001 -2.35 1 DEPT002 -2.00 1 PLU0001 -1.20 RF 1 DEPT001 -2.35 RF 1 PLU0001 -1.20 TL -2.00 CASH -2.00 </pre>
2 Register purchased item 2.	2 00 2	
3 Register purchased item 3.	1 PLU	
4 Press RF key prior to registering returned item 1.	RF	
5 Register returned item 1.	2 3 5 1	
6 Press RF key and register returned item 3. Then press SUB TOTAL key.	RF 1 PLU SUB TOTAL	
7 Press CA / AMT / TEND key as the customer paid exact amount.	CA / AMT / TEND	

To use the cash register's basic function





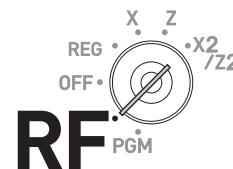

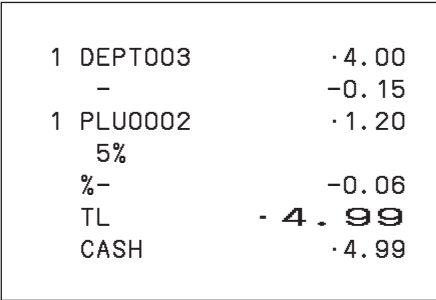

■ Registering returned goods in the RF mode

When a customer returns goods after the transaction has been completed, use RF mode for the refund operation.



Sample Operation

Refunded Item 1	Dept. 03	•4.00	A customer returned two items. Item 1 was sold with •0.15 reduction and item 2 was sold with pre-programmed 5% discount.
	Quantity	1	
	Reduced	•0.15	
Refunded Item 2	PLU 002	•1.20 (preset)	
	Quantity	1	
	Discounted	5% (preset)	
Payment	Cash	•4.99	

Step	Operation	Printout
1	Turn the Mode switch to RF position.	
2	Register the returned items by the same operations as normal registration and press  key.	
	     	
3	Press  key and pay the total amount back to the customer.	

Important

- After the refund operation, please do not forget to return the Mode switch to REG position otherwise the following registrations are stored as minus transactions.

To use the cash register's basic function

Registrations without transactions

The followings are the operations other than normal sales transactions. Please do not perform these operations during a sales transaction.

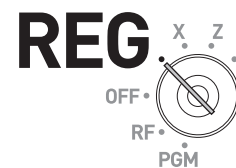

■ Registering money received on account

Use this operation when you put money in the drawer without any sales transactions such case as preparing change.

Sample Operation

Received amount	•70.00	Prepared •70.00 in the drawer for change before opening the store.
-----------------	--------	--

Step	Operation	Printout		
1 Enter the amount put in the drawer then press <input type="button" value="RA"/> key.	<input type="button" value="7"/> <input type="button" value="0"/> <input type="button" value="00"/> <input type="button" value="RA"/>	<table border="1"> <tr> <td>RA</td> <td>•70.00</td> </tr> </table>	RA	•70.00
RA	•70.00			

■ Registering money paid out from the drawer

Use this operation when you withdraw money from the drawer without any sales transactions such case as paying for a cash-on-delivery item.

Sample Operation

Paid out amount	•1.50	Paying •1.50 from the drawer.
-----------------	-------	-------------------------------

Step	Operation	Printout		
1 Enter the amount withdrawn from the drawer then press <input type="button" value="PO"/> key.	<input type="button" value="1"/> <input type="button" value="5"/> <input type="button" value="0"/> <input type="button" value="PO"/>	<table border="1"> <tr> <td>PO</td> <td>•1.50</td> </tr> </table>	PO	•1.50
PO	•1.50			

■ Opening the drawer without putting money in or out

Use this operation to open the drawer without putting money in or out. The number of key operations will be printed on X or Z reports.

If you enter numbers prior to key, the number will be printed on the receipt or journal.

Step	Operation	Printout		
1 Just press <input type="button" value="#/NS"/> key. The drawer opens.	<input type="button" value="#/NS"/>	<table border="1"> <tr> <td>#/NS</td> <td>.....</td> </tr> </table>	#/NS
#/NS			

To use the cash register's basic function

Corrections

There are three ways to correct erroneous operations that are;

- Correcting erroneous item not registered
- Correcting erroneous item already registered
- Cancelling all the items registered in a transaction

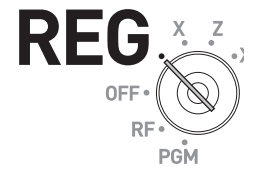

■ Correcting erroneously entered item not registered

Step	Operation	Printout
1 Correcting wrong unit price •2.00 to •1.00.	2 00 C 1 00 1	<pre> 1 DEPT001 · 1.00 11 DEPT002 ·22.00 1 PLU0003 · 1.30 1 PLU0015 ·10.00 TL - 34.30 CASH ·15.00 CHECK ·19.30 </pre>
2 Correcting wrong quantity 12 to 11.	1 2 X/DATE TIME C 1 1 X/DATE TIME 2 00 2	
3 Correcting wrong PLU number 002 to 003.	2 C 3 PLU	
4 Correcting open PLU unit price •6.00 to •10.00. You must re-enter the PLU number prior to entering correct unit price.	1 5 PLU 6 00 C 1 5 PLU 1 0 00 PRICE	
5 Correcting wrong partially tendered cash amount •10.00 to •15.00.	1 0 00 C 1 5 00 CA / AMT TEND	
6 The remaining amount is paid by check.	CHK	

To use the cash register's basic function

■ Correcting items immediately after the registration

Step	Operation	Printout
1 Registering an item.	1 00 1	
2 By mistake, Dept. key has been pressed twice so cancelling the preceding registration by ERR CORR CANCEL key.	2 00 2 2 ERR CORR CANCEL	
3 Cancelling wrong PLU registration (PLU No. 2) and re-registering correct PLU (PLU No. 5).	2 PLU ERR CORR CANCEL 5 PLU	
4 Cancelling a registration of an open PLU's (PLU No. 15) wrong unit price •6.00 and re-registering the item with the correct unit price •10.00.	1 5 PLU 6 00 PRICE ERR CORR CANCEL 1 5 PLU 1 0 00 PRICE	
5 Cancelling a registration of an item with wrong quantity (8 pieces) and re-registering the item with the correct quantity (6 pieces).	8 X/DATE TIME 4 00 4 ERR CORR CANCEL 6 X/DATE TIME 4 00 4	
6 Cancelling wrong subtotal discount calculation (with rate of 50%) and re-calculating the discount amount with the correct rate (5%).	SUB TOTAL 5 0 %- ERR CORR CANCEL SUB TOTAL 5 %-	
7 Cancelling wrong refund amount (•2.00) and re-registering correct amount (•2.20).	RF 2 00 2 ERR CORR CANCEL RF 2 2 0 2	
8 Getting the subtotal amount.	SUB TOTAL	
9 Cancelling partially tendered cash amount (•20.00) and re-registering correct amount (•15.00).	2 0 00 CA / AMT TEND ERR CORR CANCEL 1 5 00 CA / AMT TEND	
10 The customer paid the balance due by check.	CHK	

1 DEPT001	· 1.00
1 DEPT002	· 2.00
1 DEPT002	· 2.00
CORR	-2.00
1 PLU0002	· 2.00
CORR	-2.00
1 PLU0005	· 1.50
1 PLU0015	· 6.00
CORR	-6.00
1 PLU0015	· 10.00
8 DEPT004	· 32.00
CORR	-32.00
6 DEPT004	· 24.00
SUBTOTAL	· 38.50
50%	
%-	-19.25
CORR	· 19.25
SUBTOTAL	· 38.50
5%	
%-	-1.93
RF	· · · · · ·
1 DEPT002	-2.00
CORR	· 2.00
RF	· · · · · ·
1 DEPT002	-2.20
TL	- 34.37
CASH	· 20.00
CORR	-20.00
CASH	· 15.00
CHECK	· 19.37

Corrected items are not printed on receipt if programmed as "Buffered receipt printing".
See page E-75 "Set code 05".

To use the cash register's basic function

■ Voiding an item which has been already registered

Step

Display

1 During a registration.

C01	REG	000011
3	DEPT001	•6.00
1	PLU002	•2.00
3	DEPT002	•9.00
2	PLU003	•4.00
1	DEPT003	•2.00
SUBTOTAL		•24.00
QT	11	0.00

2 Using or keys, select the item you have mis-registered.

REVIEW / VOID		
1	PLU001	•1.00
3	DEPT001	•6.00
1	PLU002	•2.00
3	DEPT002	•9.00
2	PLU003	•4.00
1	DEPT003	•2.00
Select & <CA/AMT TEND> or CANCEL:<SUB TOTAL>		0.00



3 Press key. The selected item is voided.

C01	REG	000011
2	PLU003	•4.00
1	DEPT003	•2.00
1	DEPT003	•2.00
SUBTOTAL		•22.00
QT	10	0.00

To use the cash register's basic function

■ Cancelling all items in a transaction

Step

1 Press  key after items have been registered then press  key.

2 Select [YES] on the pop up display.

3 Press  key. The registered items are cancelled.

Display

C01	REG	000011
3	DEPT001	•6.00
1	PLU002	•2.00
3	DEPT002	•9.00
2	PLU003	•4.00
1	DEPT003	•2.00
SUBTOTAL		•24.00
QT	11	0.00

C01	000011
CANCEL OPEARTION	
Please select	
Yes	:<CA/AMT TEND>
No	:<C>
ST	
•24.00	
QT	11 0.00

C01	REG	000011
1	PLU002	•2.00
3	DEPT002	•9.00
2	PLU003	•4.00
1	DEPT003	•2.00
CANCEL	
SUBTOTAL		•0.00
CANCEL		0.00

To use the cash register's basic function

Daily sales reports

At the end of the business day, you can print categorized and summarized results of the day. Reset report (Z) clears all the sales data whereas the data remains in memory by Read report (X).

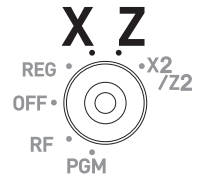

NOTE Please do not perform the Reset report (Z) printing while your store is open. It clears all the sales data.

Step

1 Turn the Mode switch to X or Z position. The display shows top display of sales reports.

Display

C01	Z	000011
[DAILY Z]		
[PLU]		
[GROUP]		
[HOURLY]		
[MONTHLY]		
[OPEN CHK]		
[EJ]		
Select and <CA/AMT TEND>		
		0.00

2 Select [DAILY Z] (DAILY X when you set the Mode switch to X) and press  key. The printer prints a sales report.

Further operations:

- For individual reports, please see page E-103.

To use the cash register's basic function

Print out of daily sales report

Z	20-06-2018	17:00	1
	0001	000231	2

Z	DAILY Z		3

Z	DEPT	0001	4
		0001015	5
DEPT001		203.25	6
		·1,108.54	
DEPT002		183	
		·1,362.26	
		5	
		47.00	

TL		421.25	7
		·2,872.28	

Z	FIX	0001	8
		0001011	9
GROSS		981.25	
		·6,574.40	10
NET	No 111		
		·7,057.14	11
CAID		·1,919.04	12
CHID		·139.04	13
CKID		·859.85	14
CRID(1)		·709.85	15
CRID(2)		·0.00	16
CRID(3)		·0.00	17
CRID(4)		·0.00	18

RF	No	3	19
		·10.22	
CUST	CT	111	20
AVRG		·63.57	21
DC		·1.22	22
REF		·2.42	23
ROUND		·0.00	24
CANCEL	No	2	25
		·12.97	

- 1 Date/time
- 2 Machine No./consecutive No.
- 3 Report title
- 4 Department report title/reset counter
- 5 Report code
- 6 Department count/amount *1
- 7 Department total count/total amount
- 8 Fixed total report title/reset counter
- 9 Report code
- 10 Gross total *2
- 11 Net total *2
- 12 Cash in drawer *2
- 13 Charge in drawer *2
- 14 Check in drawer *2
- 15 Credit in drawer 1 *2
- 16 Credit in drawer 2 *2
- 17 Credit in drawer 3 *2
- 18 Credit in drawer 4 *2
- 19 Refund mode *2
- 20 Number of customer *2
- 21 Average sales per customer *2
- 22 Discount total *2
- 23 Refund key *2
- 24 Rounding total *2
- 25 Cancellation

* 1 If total amount is zero, these items will not be printed.

* 2 These items can be skipped by programming. See page E-77 "Set code 08".

To use the cash register's basic function

TA1		·2,369.69	26
TX1		·128.86	27
TA2		·2,172.96	28
TX2		·217.33	29

GT		·00000000125478.96	30

Z	TRANS	0001	31
		0001012	32
CASH	No	362	33
		·1,638.04	
CHARGE	No	56	
		·1,174.85	
RA	No	4	
		·810.00	
P0	No	5	
		·520.00	
		·5.00	
CORR	No	14	
		·39.55	
RCT	No	3	
NS	No	5	

- 26 Taxable 1 amount *2
- 27 Tax 1 amount *2
- 28 Taxable 2 amount *2
- 29 Tax 2 amount *2
- 30 Grand total *2
- 31 Function key report title/reset counter
- 32 Report code
- 33 Function key count/amount *1

* 1 If total amount is zero, these items will not be printed.

* 2 These items can be skipped by programming. See pages E-79 "Set code 09" and E-81 "Set code16".

Advanced programmings and registrations

Advanced registrations.....	E-53
Enabling clerk assignment.....	E-53
Registrations with clerk assignment.....	E-54
Single item cash sales	E-55
Transactions in local and foreign currencies	E-57
Other operations.....	E-60
Character settings.....	E-64
Using character keyboard.....	E-64
Using ten key pad	E-65
Setting characters	E-67
Setting symbol characters	E-68
Advanced programmings	E-72
Programming detail settings	E-73
Programming functions of departments and PLUs in a lump	E-86
Programming department functions in a lump	E-86
Programming PLU functions in a lump	E-88
Programming functions of departments and PLUs individually	E-89
Programming functions of departments individually.....	E-89
Programming functions of PLUs individually.....	E-91
Programming functions of transaction keys	E-92
Programming further clerk functions.....	E-97
Printing programmed data	E-98
To print programmed unit price or percentage (other than PLU)	E-98
To print programmed characters (except PLUs)	E-99
To print general programming (except PLUs).....	E-100
To print preset unit price of PLU	E-101
To print preset characters of PLU.....	E-102
To print PLU programmings	E-102
Printing various sales reports.....	E-103
Printing various sales reports.....	E-103
To print individual department and PLUs	E-107
Periodic sales report.....	E-108
Bluetooth setting	E-111
Setting Bluetooth pairing	E-111
Using an SD card.....	E-113
To format an SD card.....	E-114
To store program data in an SD card.....	E-115
Restoring backup data (automatically backed up setting data) from built in flash memory	E-116
POP setting	E-116
Handling of the cash drawer	E-117
To lock and unlock the cash drawer	E-117
To pull out the cash drawer	E-117
To remove coin divider (certain models).....	E-118
Before you consider it as a problem	E-119
Error code table	E-119
About HELP guidance	E-122

Advanced programmings and registrations

When “EJ FULL” sign appears on the display.....	E-123
In case of power failure.....	E-123
In case the register is locked up.....	E-123
About the low battery indicator	E-124
About open source code	E-124
Specifications	E-125

Advanced registrations

Enabling clerk assignment

By assigning a clerk, clerk number or name will be printed on receipts. The following operation enables the register to use the clerk assignment.



Step

1 Turn the Mode switch to PGM position. The display shows programming top menu.

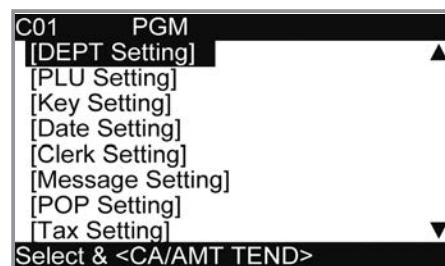

2 Using or keys, select [General Setting] and press key.

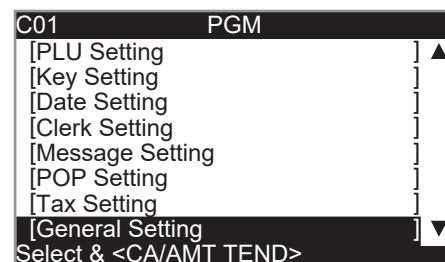

3 Select [Enable Clerk] and press key.

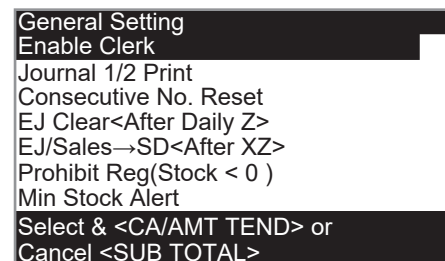

4 Using or keys, select [YES] and press key.

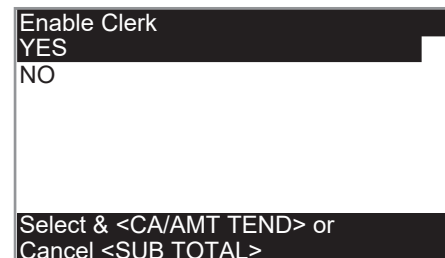

Advanced programmings and registrations

Registrations with clerk assignment

By signing a clerk on, the clerk name will be printed on receipts and sales reports.

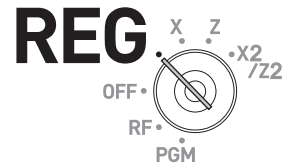

Step	Operation	Printout
1 Enter the clerk number and press <input type="button" value="CLK#"/> key.	1 <input type="button" value="CLK#"/>	<pre>* commercial message * REG 20-06-2018 11:58 C01 0001 000123 1 1 DEPT01 T1 .1.00</pre>
2 Perform registration operations. The clerk name is printed on receipts and displayed on top of the display.		
3 To sign a clerk off, enter 0 and <input type="button" value="CLK#"/> key. Or just press <input type="button" value="SIGN OFF"/> key.	0 <input type="button" value="CLK#"/>	1: Clerk Name/Machine No./Consecutive No.

Further operation:

You can sign on the register by clerk's secret number instead of clerk number. See page E-30.

Advanced programmings and registrations

Single item cash sales

A department key or a PLU programmed as single item sale status finalizes the transaction as soon as it is registered. This feature can be used only in cash sales. To program single item sales status see pages E-29.

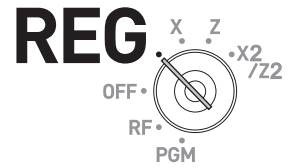

Sample operation 1: Simple single item sale

Item	Dept. 01	•1.00	Dept. 01 is programmed as single item sale and unit price is not preset.
	Quantity	1	
	Preset	Single item	
Payment	Cash	•1.00	

Step	Operation	Printout
1 Enter the unit price then press corresponding department key. The transaction is finalized immediately after the department key depression.	1 00 1	<pre> 1 DEPT001 . 1.00 TL - 1.00 CASH . 1.00 </pre>

Sample operation 2: Single item sale with multiplication

Item	Dept. 01	•1.00	Selling three pieces of items of dept. 01 in which unit price •1.00 and single item sale status is pre-programmed.
	Quantity	3	
	Preset	Single item	
Payment	Cash	•3.00	

Step	Operation	Printout
1 Enter the quantity and press key for multiplication.	3	<pre> 3 DEPT001 . 3.00 TL - 3.00 CASH . 3.00 </pre>
2 Press corresponding department key. The transaction is finalized immediately.	1	

Advanced programmings and registrations

Sample operation 3: Single item sale with another item

Item 1	Dept. 03	•2.00	Dept. 03 is a normal department while dept. 01 is programmed as unit price •1.00 and single item sale status.
	Quantity	1	
	Preset	Normal	
Item 2	Dept. 01	•1.00	
	Quantity	1	
	Preset	Single item	
Payment	Cash	•3.00	

Step	Operation	Printout								
1 Register item 1.	2 00 3	<table border="1"> <tr> <td>1 DEPT003</td> <td>•2.00</td> </tr> <tr> <td>1 DEPT001</td> <td>•1.00</td> </tr> <tr> <td>TL</td> <td>- 3.00</td> </tr> <tr> <td>CASH</td> <td>•3.00</td> </tr> </table>	1 DEPT003	•2.00	1 DEPT001	•1.00	TL	- 3.00	CASH	•3.00
1 DEPT003	•2.00									
1 DEPT001	•1.00									
TL	- 3.00									
CASH	•3.00									
2 Single item sale department key does not finalize the transaction as it is not single item sale.	1									
3 Press <input type="button" value="CA/AMT/TEND"/> key to finalize the transaction.	<input type="button" value="CA/AMT/TEND"/>									

Advanced programmings and registrations

Transactions in local and foreign currencies

Using **[CE]** key, you can register other currencies with exchange calculations. For example, registering items in local currency and payment in US dollars etc.

NOTE To set currency symbol (only ¥, £, and \$) on receipts, see page E-71.

■ To set currency rate

1 From the following table, check the relation of ADD values (number of decimal place e.g., 1.23 = (ADD = 2), 12.3 (ADD = 1), 123 (ADD = 0) between the main currency and a sub currency.

Case	Main Currency	Sub currency	Exchange rate value N
1	ADD =2	ADD = 0	100 [sub currency] = N [main currency]
2	ADD =2	ADD = 1	10 [sub currency] = N [main currency]
3	ADD =2	ADD = 2	1 [sub currency] = N [main currency]
4	ADD =0	ADD = 0	1 [sub currency] = N [main currency]
5	ADD =0	ADD = 1	0.1 [sub currency] = N [main currency]
6	ADD =0	ADD = 2	0.01 [sub currency] = N [main currency]

2 Calculate the exchange rate value.

Example 1: Main currency is £ (ADD 2) and sub currency is US\$ (ADD 2) (Case 3 in the above table) and exchange rate \$1.00 (sub currency) = £0.6374 (main currency), the exchange rate value N will be 0.6374.

Example 2: Main currency is DM (ADD 2) and sub currency is JP¥ (ADD 0) (case 1 in the above table) and exchange rate JP¥100. = DM 0.9524, the exchange rate value N will be 0.9524.

3 Turn the Mode switch to PGM position and select [Key Setting]. On the sub menu of key setting screen select [CE].

4 Input the exchange rate value "N" in RATE column.

5 Enter ADD value of sub currency 0, 1, or 2 in MONETARY MODE column.

6 Press **[CA/AMT/TEND]** key to complete the setting.

Advanced programmings and registrations

■To transact in local and foreign currencies

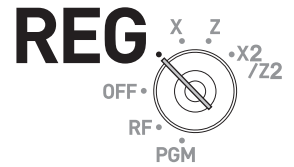

Sample operation 1: Full payment in foreign cash

Item 1	Unit price	•10.00	Main currency: Local Sub currency: JP Yen Exchange rate: ¥100 = •0.9524 Payment: in Yen Change: in local currency
	Quantity	1	
	Dept.	01	
Item 2	Unit price	•20.00	
	Quantity	1	
	Dept.	02	
Payment		¥5,000	

Step

Operation

Printout

1 Register the item 1.

1 **0** **00** **1**

2 Register the item 2.

2 **0** **00** **2**

3 Press **CE** and **SUB TOTAL** keys.
The display indicates the sub total amount in sub currency (JP¥3,150 in this case).

CE **SUB TOTAL**

4 Enter the tendered amount in sub currency and press **CE** key.
The display indicates the amount in local currency.

5 **0** **00** **CE**

5 Press **CA/AMT/TEND** key. The display shows the change amount in local currency.

CA/AMT/TEND

```

1 DEPT001      · 10.00
1 DEPT002      · 20.00
TL             - 30.00
CE
CASH           ¥5,000
CASH           · 47.62
CG             · 17.62
    
```

Advanced programmings and registrations

Sample operation 2: Partial payment in foreign cash and local check

Item 1	Unit price	•10.00	Main currency: Local Sub currency: JP Yen Exchange rate: ¥100 = •0.9524 Payment: ¥2,000 in cash and the rest by check in local currency.
	Quantity	1	
	Dept.	01	
Item 2	Unit price	•20.00	
	Quantity	1	
	Dept.	02	
Payment	Cash	¥2,000	
	Check	•10.95	

Step

Operation

Printout

1 Register the item 1.

1 **0** **00** **1**

2 Register the item 2.

2 **0** **00** **2**

3 Press **CE** and **SUB TOTAL** keys. The display indicates the sub total amount in sub currency (JP¥ in this case).

CE **SUB TOTAL**

4 Enter partially tendered amount in foreign currency and press **CE** key. The display indicates the amount in local currency.

2 **0** **00** **CE**

5 Press **CA/AMT TEND** key. The display indicates the deficit in local currency.

CA/AMT TEND

6 Press **CHK** key after receiving a check in local currency.

CHK

```

1 DEPT001      · 10.00
1 DEPT002      · 20.00
TL             - 30.00
CE
CASH           ¥2,000
CASH           · 19.05
CG             · 10.95
    
```

NOTE Finalization in a foreign currency can be registered only by **CA/AMT TEND** or **CHK** keys.

Advanced programmings and registrations

Other operations

■ Transactions with coupons

Using **CPN** key, you can register sales with coupons.

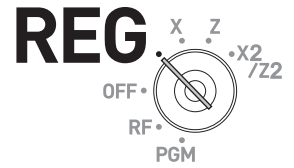

Sample operation

Item 1	Dept. 01	•3.00	Customer paid two •0.50 coupons for item 1 and a •1.00 coupon for item 2. Amount•1.00 is preprogrammed in CPN key.
	Quantity	2	
	Coupon.	•0.50 × 2	
Item 2	Dept. 03	•4.00	
	Quantity	1	
	Coupon.	•1.00 (preset)	
Payment	Cash	•8.00	

Step

Operation

Printout

1 Register the item 1.

2 **3 00**

2 Use multiplication key for the number of coupons.

2

3 Enter the amount of a coupon and press **CPN** key.

5 0

4 Register item 2.

4 00

5 Without entering a price of a coupon, press **CPN** key for preset coupon price.

6 Press key to finalize the transaction.

2	DEPT001	•6.00
	COUPON	-1.00
1	DEPT003	•4.00
	COUPON	-1.00
	TL	- 8.00
	CASH	•8.00

NOTE

An error occurs if the register is programmed to prohibit credit balance and the result of a calculation is negative.

Advanced programmings and registrations

■ VAT breakdown printing

You can force printing of VAT breakdown at the finalize stage, regardless of whether the cash register is programmed to print or skip printing of the VAT breakdown.

Sample operation

Item 1	Dept. 01	•1.00	<ul style="list-style-type: none"> • Dept. 01 is programmed as taxable 1 and PLU 0001 is programmed as taxable 2. • Printing breakdowns of those taxes.
	Taxable status	1 (preset)	
Item 2	PLU 0001	•2.00 (preset)	
	Taxable status	2 (preset)	
Payment	Cash	•3.00	

Step	Operation	Printout
1 Register the item 1.	1 00 1	<pre> 1 DEPT001 T1 -1.00 1 PLU0001 T2 -2.00 TA1 -0.90 TX1 -0.10 TA2 -1.90 TX2 -0.10 TL -3.00 CASH -3.00 </pre>
2 Register the item 2	1 PLU	
3 Press VAT key to print breakdowns of taxes.	VAT	
4 Press CA / AMT / TEND key to finalize the transaction.	CA / AMT / TEND	

Advanced programmings and registrations

■ To transact in Euro

By using **PD** key, the register allows you to register items in the local currency and transact in Euro or vice versa. To set the currency rate between Euro and local currency, please see page E-83.

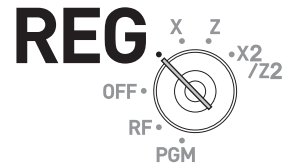

Sample Operation 1

Item	Unit price	•6.00	Main currency: Local Sub currency: Euro A •6.00 item is sold and the customer paid in Euro.
	Quantity	1	
	Dept.	01	
Exchange rate	€1.00 = •0.50		
Payment	€15.00		

Step	Operation	Printout
1 Register the item in local currency.	6 00 1	<pre> 1 DEPT001 T1 •6.00 TL - 6.00 (€12.00) EURO money CASH €15.00 CASH (•7.50) CG •1.50 (€3.00) </pre>
2 Press PO key. The register calculates the price in Euro.	PO	
3 Press SUB TOTAL key to indicate the price in Euro.	SUB TOTAL	
4 Press PO key before entering tendered amount in Euro.	PO	
5 Enter the tendered amount in Euro.	1 5 00	
6 Press CA/AMT /TEND key. The display indicates the change in local currency.	CA/AMT /TEND	

Advanced programmings and registrations

Sample Operation 2

Item	Unit price	€12.00	Main currency: Euro Sub currency: Local A €12.00 item is sold and the customer paid in local currency.
	Quantity	1	
	Dept.	01	
Exchange rate	•1.00 = €2.00		
Payment		•10.00	

Step	Operation	Printout
1 Register the item in Euro.	1 2 00 1	<pre> 1 DEPT001 €12.00 TL €12.00 (·6.00) LOCAL money CASH ·10.00 CASH (€20.00) CG €8.00 (·4.00) </pre>
2 Press PO key. The register calculates the price in local currency.	PO	
3 Press SUB TOTAL key to indicate the price in local currency.	SUB TOTAL	
4 Press PO key before entering tendered amount in local currency.	PO	
5 Enter the tendered amount in local currency.	1 0 00	
6 Press CA / AMT / TEND key. The display indicates the change in Euro.	CA / AMT / TEND	

Advanced programmings and registrations

Character settings

This chapter explains how you can program department or PLU descriptions, store messages, key descriptions, report title, total descriptions (such as gross total, net total etc.) and clerk names.

There are two ways to program characters which are using character keyboard and using multi typing of ten key.

Using character keyboard

■ Character keyboard

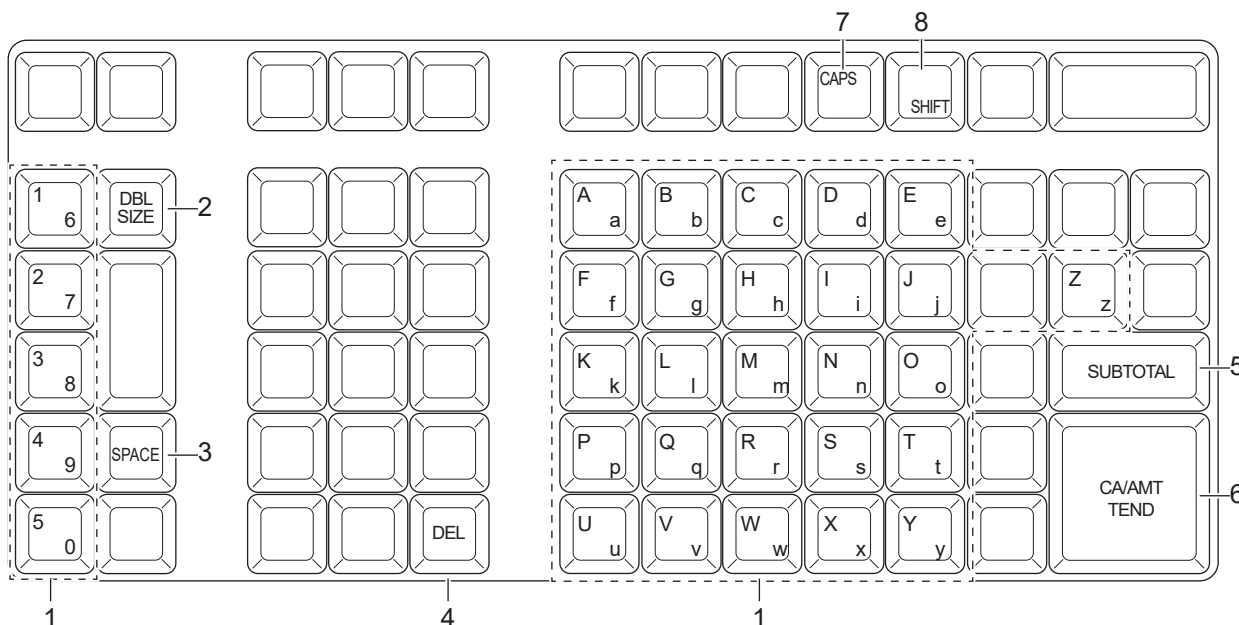

- | | |
|--|---|
| <p>1 Alphabet keys</p> <p>2 Double size letter key</p> <p>3 Space key</p> <p>4 Delete key</p> <p>5 Program end key</p> <p>6 Character enter key</p> <p>7 CAPS key</p> <p>8 Shift key</p> | <p>Used to input characters.</p> <p>Assigns the next input character to be double sized. After setting a double sized character, press this key again to back to normal size.</p> <p>Sets a space.</p> <p>Clears the last input character.</p> <p>Terminates the character programming.</p> <p>Registers the programmed characters.</p> <p>Pressing this key shifts a character from the lowercase letter to upper case letter.</p> <p>Pressing this key shifts the character from the uppercase letter to lower case letter.</p> |
|--|---|

Example: To set "Apple Juice"

A **p p l e** **J** **u i c e**
 <DBL> <A> <DBL> <Shift> <p> <p> <l> <e> <Space> <CAPS> <J> <Shift> <u> <i> <c> <e> .

Advanced programmings and registrations

Using ten key pad

To set characters by using ten key, you need to press one of the ten key repeatedly until desired character appears on the display.

Multi typing keyboard

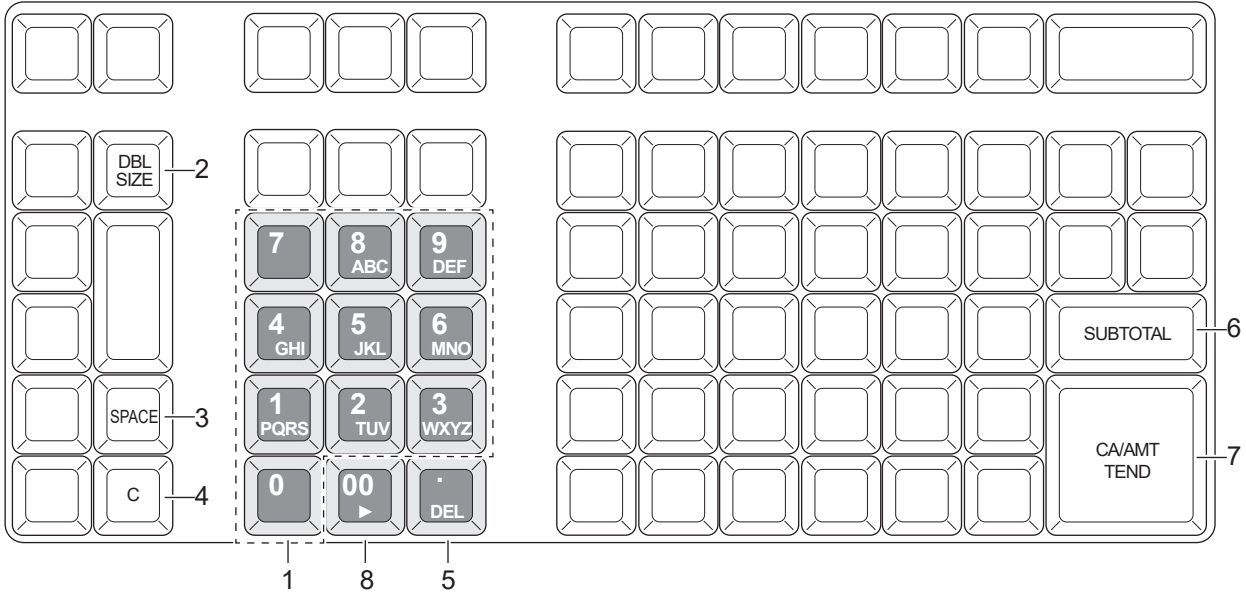

1 Alphabet keys

Hitting one of those keys repeatedly changes characters in the order shown in the table below.

8	A → B → C → a → b → c → 8 → Ä → Å → Æ → Á → Â → Æ → Å → Ç → â → ä → à → á → æ → á → ä → Ç returns to the beginning
9	D → E → F → d → e → f → 9 → ð → É → Ê → Ë → È → ð → é → ê → ë → è → f returns to the beginning
4	G → H → I → g → h → i → 4 → Í → Î → Ï → I → Ì → Î → Î → í → i returns to the beginning
5	J → K → L → j → k → l → 5 returns to the beginning
6	M → N → O → m → n → o → 6 → Ñ → Ö → ø → Ó → Ô → Ò → Õ → ñ → ô → ö → ò → ø → ó → õ returns to the beginning
1	P → Q → R → S → p → q → r → s → 1 → þ → þ → ß returns to the beginning
2	T → U → V → t → u → v → 2 → TEL → Ü → Ú → Û → Û → ü → Û → ù → ú → μ returns to the beginning
3	W → X → Y → Z → w → x → y → z → 3 → ŷ → ŷ → ŷ returns to the beginning
0	0
00	(Right cursor)
.	(Delete)
7	7 → @ → - → / → : → ! → ? → ~ → (→) → * → # → + → , → ^ → ; → < → → = → > → \$ → ¥ → % → & → [→] → ' → { → → } → • → “ → . → \ → _ → ` → £ → x → ÷ → i → € → § → ¢ → space returns to the beginning

Advanced programmings and registrations

- 2 **Double size letter key** Assigns the next input character to be double sized. After setting a double sized character, press this key again for normal size.
- 3 **Space key** Sets a space.
- 4 **Clear key** Clears all the characters.
- 5 **Delete key** Clears the last input character.
- 6 **Program end key** Terminates the character programming.
- 7 **Character enter key** Registers the programmed characters.
- 8 **Right cursor key** Moves the cursor to the right.



Example: To set CLASS a

C L A S S a

<DBL> 8 8 8 5 5 5 <DBL> 8 1 1 1 1 00 1 1 1 1 <Space> 8 8 8 8

Advanced programmings and registrations

Setting characters

The following explanation shows how you can set a name in a PLU. You can also set names to departments, function keys (, ), and clerks by the same method.

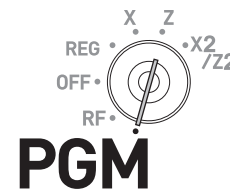





Sample Operation



To set "MILK" to PLU0001 by using ten key pad.

Step

1 Turn the Mode switch to PGM position. The display shows the program top menu.

2 Using  or  keys, select [PLU Setting] and press  key.

Enter the PLU number in which you wish to set characters and press  key.

3 On the next screen, make sure that the PLU number you wish to set is selected. If you wish to change it, use  or  keys.

Press  key.

4 Select the top column of the [PLU Setting screen] and input the character you wish to set. In this example, **6 4 4 4 5 5 5 00 5 5** (for MILK). Then press  key to complete the setting.

Display

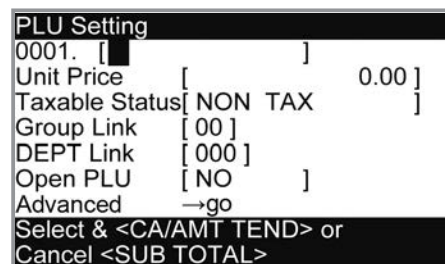
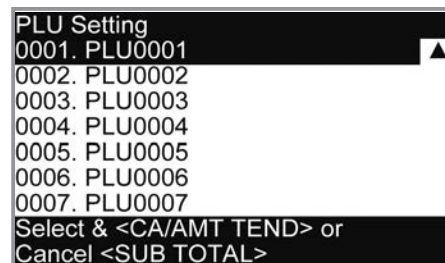
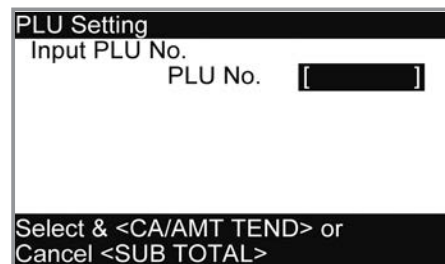
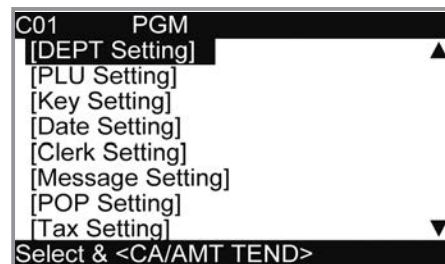

Advanced programmings and registrations

Setting symbol characters

You can change the symbols or titles of sales reports for example, printing “CASH IN DRW” on the sales reports instead of “CAID” for cash amount in drawer.

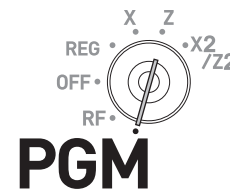

Step	Operation
<p>1 Turn the Mode switch to PGM position and select [System Setting] then press key.</p> <p>[System Setting] is the last column on the programming top menu and is not shown on the first screen. Keep pressing key until it appears on the screen.</p>
<p>2 Enter 2 and press key to set the register in the character setting mode.</p>	2
<p>3 Referring the following tables, enter two-digit memory number and program code. Then press key.</p>	 [Memory No.](Program code)
<p>4 Referring the character entry methods on pages E-64 and E-65, input characters you wish to set and press key.</p> (Character keys)
<p>5 If you wish to set in the next memory number, repeat step 4. If you wish to set other memory number than the next number, repeat steps 3 and 4.</p>	
<p>6 Press key to complete the setting.</p>	

Example: To set “CASH IN DRW” in memory number 3

Press **0** **3** **0** **1** [C][A][S][H][SPACE][I][N][SPACE][D][R][W]

Advanced programmings and registrations

Sales report symbols

Memory No.	Program code	Contents	Default character	Memo for your settings
01	01	Gross total	GROSS	
02		Net total	NET	
03		Cash in drawer	CAID	
04		Charge in drawer	CHID	
05		Check in drawer	CKID	
06		Credit 1 in drawer	CRID(1)	
07		Credit 2 in drawer	CRID(2)	
08		Credit 3 in drawer	CRID(3)	
09		Credit 4 in drawer	CRID(4)	
10		Cash in drawer for sub currency	CAID2	
11		Charge in drawer for sub currency	CHID2	
12		Check in drawer for sub currency	CKID2	
17		Refund mode total	RF	
18		Customer count	CUST	
19		Average sales per customer	AVRG	
20		Clerk commission 1 total	C-1	
21		Clerk commission 2 total	C-2	
22		Foreign currency cash in drawer	CECA1	
23		Foreign currency check in drawer	CECK1	
26		Reduction	DC	
27		Coupon	COUPON	
28		Item return	REF	
29		Rounding for sub currency	ROUND	
30		Rounding	ROUND	
31		Cancellation	CANCEL	
33		Taxable amount 1	TA1	
34		Tax 1	TX1	
35		Taxable amount 2	TA2	
36		Tax 2	TX2	
37		Taxable amount 3	TA3	
38		Tax 3	TX3	
39		Taxable amount 4	TA4	
40		Tax 4	TX4	
41		Taxable amount 5	TA5	
42		Tax 5	TX5	
43		Taxable amount 6	TA6	
44		Tax 6	TX6	
45		Taxable amount 7	TA7	
46		Tax 7	TX7	
47		Taxable amount 8	TA8	
48		Tax 8	TX8	
49		Taxable amount 9	TA9	
50		Tax 9	TX9	
51		Taxable amount 10	TA10	
52		Tax 10	TX10	

Advanced programmings and registrations

Memory No.	Program code	Contents	Default character	Memo for your settings
53	01	Tax total	TAX TOTAL	
54		Non taxable amount	NON TAX	

Advanced programmings and registrations

Other symbols

Numbers in () are digits to be used.

Memory No.	Program code	Contents	Default character
01	23	main currency symbol (2), @ (2), No.(2), split pricing (2), not used (4), sub currency symbol (2)	· @ N o / * *
02		No. of item sold (2), No. of customers (2), not used (6), multiplication display(2)	N o C T @ L B * Q T
03		multiplication symbol (6), not used (6)	X B U S Y
04		taxable symbols (3 each)	T 1 T 2 T 3 T 4 T 5
05		taxable symbols (3 each)	T 6 T 7 T 8 T 9 T 1 0
06		taxable symbols (3 each)	T 1 2 T 1 3 T 1 4 T 2 3
08		foreign currency (2 each) not used (8)	* * * * *
09		mode symbols (4 each) (REG, RF, not used)	R E G R F R -
10		mode symbols (4 each) (PGM, Daily X, Daily Z, Periodic)	P n x Z X Z
11		mode symbols (4 each) (not used, PGM read)	T R G P G M X
12		decimal (1) (for amount/ q'ty), separator (main/sub 1 each), not used (3), square (7)	· · · · · , X
13		am, pm (3each) ST symbol on main display (2)	A M P M S T
16		subtotal symbol on main display (16)	S U B T O T A L
17		subtotal symbol for discount/premium (16)	S U B T O T A L
18		post receipt total symbol (16)	T L
19		change symbol (16)	C G
01		20	grand total symbol (16)

Title of sales reports

Memory No.	Program code	Contents	Default character	Memo for your settings
01	24	Fixed total report title	FIX	
02		Transaction key report title	TRANS	
03		PLU sales report title	PLU	
04		Department sales report title	DEPT	
05		Group sales report title	GROUP	
06		Clerk sales report title	CASHIER	
08		Hourly sales report title	HOURLY	
09		Monthly sales report title	MONTHLY	
16		Flash report title	FLASH	

Advanced programmings and registrations

Advanced programmings

This section explains how you can program detail settings of the register such as setting register's specific number, whether to reset consecutive number on the receipt after a Reset (Z) report or not, whether to print taxable amounts on receipts or not, etc.

The following table lists what can be programmed in this settings.

Set code	Settings	No. of digit to be set
02	Cash register's unit number	4
03	Whether to reset consecutive number after Reset (Z) report or not	8
04	Tax and rounding systems	10
05	Contents of receipt/journal print	10
06	Calculation and operation methods	10
08	Contents of sales reports 1	10
09	Contents of sales reports 2	10
10	Whether to print taxable amount or not	10
14	Currency exchange	8
15	Printing methods of sales reports	10
16	Printing methods of grand total	7
17	Date/time printing on journals/receipts	4
19	Double height character printing on receipts	7
21	Printing methods of messages	10
25	Entry restriction	1
27	Clerk operation selections	9
28	Euro settings 1	10
29	Euro settings 2	10
30	Receipt message/Compressed journal print selection	5
34	Backlight on/off selection	4

Advanced programmings and registrations

Programming detail settings

To program the detail settings of the register, please follow the operations shown below.

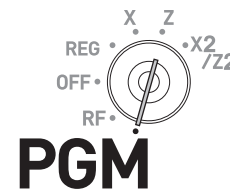

Step	Operation
------	-----------

1 Turn the Mode switch to PGM position and select [System Setting] then press key.



[System Setting] is the last column on the programming top menu and is not shown on the first screen. Keep pressing key until it appears on the screen.

2 Enter and press key to set the register in the programming mode.



3 Referring the following tables, enter two-digit set code you wish to program followed by two 2s. "22" is the identification code for programming detail settings.



[set code]

For example, if you wish to program tax system:



4 Referring the tables below, enter program code of up to 10 digits and press key.



[Program code (up to 10 digits)]

5 Press key to complete the program.



Set code 02 (Machine number)

Description	Selection	Program code	Default value
Machine number	Machine number	<input type="text"/> <input type="text"/> <input type="text"/> <input type="text"/> D4 D3 D2 D1	<input type="text" value="0"/> <input type="text" value="0"/> <input type="text" value="0"/> <input type="text" value="0"/> D4 D3 D2 D1

Example: To set the register's specific unit number 1234.

Press

Set code 03 (Whether to reset consecutive number after Reset (Z) report or not)

Description	Selection	Program code	Default value
Reset consecutive number after daily reset report is issued.	Yes = 0 No = 1	<input type="text"/> D8	<input type="text" value="0"/> D8
Must be "0000000" (seven zeros)		<input type="text"/> to <input type="text"/> D7 to D1	<input type="text" value="0"/> to <input type="text" value="0"/> D7 to D1

Example: Not resetting the consecutive number after Z report printing.

Press

Advanced programmings and registrations

Set code 04 (Tax and rounding systems)

Description	Selection	Program code	Initial value
Apply rounding for registration: No rounding = 0, IF1 = 1, IF2 = 2, Danish = 3, Norwegian = 4, Singaporean = 5, Finnish = 6, Australian = 7, South African = 8, Other roundings = 9 (Refer to D1) See the following tables for IF1 and IF2	0 to 9	<input type="checkbox"/> D10	<input type="checkbox"/> 0 D10
Tax system: Single tax system (1 ~ 4) = 0, Singaporean tax system = 3, Indian tax system = 4	0,3 or 4	<input type="checkbox"/> D9	<input type="checkbox"/> 0 D9
Must be "0000000"		<input type="checkbox"/> to <input type="checkbox"/> D8 to D3	<input type="checkbox"/> 0 to <input type="checkbox"/> 0 D8 to D3
Print invoice No.	No = 0 Yes = 1	<input type="checkbox"/> D2	<input type="checkbox"/> 0 D2
Other rounding: New Zealander (A) = 0, New Zealander (B) = 1, Malaysian = 2, Czech = 3 (D10 must be set to "9".)	0 to 3	<input type="checkbox"/> D1	<input type="checkbox"/> 0 D1

Rounding systems for each country

IF 1 rounding	
Last digit of ST	Result
0 to 2	0
3 to 7	5
8 to 9	10

Australian rounding	
Last digit of ST/CA CG	Result
0 to 2	0
3 to 7	5
8 to 9	10

IF 2 rounding	
Last digit of ST	Result
0 to 4	0
5 to 9	10

South African rounding	
Last digit of ST	Result
0 to 4	0
5 to 9	5

Danish rounding	
Last 2 digits of ST/CA CG	Result
00 to 24	00
25 to 74	50
75 to 99	100

New Zealander (A/B) rounding	
Last digit of ST/CA CG	Result
0 to 4/5	0
5/6 to 9	10

Singaporean rounding	
Last digit of item, %- REG	Result
0 to 2	0
3 to 7	5
8 to 9	10

Malaysian rounding	
Last digit of ST/ CA CG	Result
0 to 2	0
3 to 7	5
8 to 9	10

Finnish rounding	
Last digit of ST/CA CG	Result
0 to 2	0
3 to 7	5
8 to 9	10

Czech rounding	
Last digit of ST	Result
00 to 49	00
50 to 99	100

Norwegian rounding	
Last 2 digits of ST	Result
00 to 24	00
25 to 74	50
75 to 99	100

Advanced programmings and registrations

Set code 05 (Receipt printing selections)

Description	Selection	Program code	Default value
Print total line during finalization.	a Yes = 0 No = 1	<input type="checkbox"/> (a+b) D10	<input type="text" value="0"/> (a+b) D10
24- hour system (0) or 12 -hour system (2)	b Select 0 or 2		
Buffered receipt print (enables key operations during printing)	No = 0 Yes = 2	<input type="checkbox"/> D9	<input type="text" value="0"/> D9
Skip item prints on journal. (journal skip)	No = 0 Yes = 1	<input type="checkbox"/> D8	<input type="text" value="0"/> D8
Must be "000"		<input type="text" value="0"/> <input type="text" value="0"/> <input type="text" value="0"/> D7 D6 D5	<input type="text" value="0"/> <input type="text" value="0"/> <input type="text" value="0"/> D7 D6 D5
Print number of item sold. (item counter)	a No = 0 Yes = 1	<input type="checkbox"/> (a+b) D4	<input type="text" value="2"/> (a+b) D4
Print tax symbols.	b Yes = 0 No = 2		
Must be "000"		<input type="text" value="0"/> <input type="text" value="0"/> <input type="text" value="0"/> D3 D2 D1	<input type="text" value="0"/> <input type="text" value="0"/> <input type="text" value="0"/> D3 D2 D1

Example:

- On a receipt, not printing total amount (a = 1), printing 12 -hour system (b = 2): D10 = 3 (1 + 2).
- Buffered receipt printing: D9 = 2.
- Not printing items on journal (journal skip): D8 = 1.
- D7 – D5 must be 000.
- Printing number of items (a = 1), not printing tax symbols (b = 2): D4 = 3 (1 + 2).
- D3 – D1 must be 000.

Press **3** **0 5 2 2** **3 2 1 0 0 0 3 0 0 0**

Advanced programmings and registrations

Set code 06 (Calculation and operation methods)

Description	Selection	Program code	Default value
Succeeds the taxable status and commission status of previous item when +/- operation is performed.	a Yes = 0 No = 1	<input type="checkbox"/> (a+b) D10	<input type="checkbox"/> (a+b) D10
Force money declarations before read(X) or reset (Z) reports operations.	b No = 0 Yes = 4		
Force to press <input type="button" value="SUB TOTAL"/> key before finalization.	a No = 0 Yes = 1		
Allow finalization when subtotal amount is zero or minus.	b Yes = 0 No = 2	<input type="checkbox"/> (a+b+c) D9	<input type="checkbox"/> (a+b+c) D9
Allow multiple refund operation.	c Yes = 0 No = 4		
Affects the results of +/-, %+/%- calculations to items. (Net totaling)	No = 0 Yes = 1	<input type="checkbox"/> D8	<input type="checkbox"/> D8
Include commission in net total.	Yes = 0 No = 2	<input type="checkbox"/> D7	<input type="checkbox"/> D7
Clears the key buffer when a receipt is issued. (REG mode only)	a No = 0 Yes = 1		
Sounds key catch tone.	b Yes = 0 No = 2	<input type="checkbox"/> (a+b+c) D6	<input type="checkbox"/> (a+b+c) D6
Allow to issue post receipt, even the original one is issued.	c No = 0 Yes = 4		
Must be "000"		<input type="checkbox"/> <input type="checkbox"/> <input type="checkbox"/> D5 D4 D3	<input type="checkbox"/> <input type="checkbox"/> <input type="checkbox"/> D5 D4 D3
Using <00> key as <000> key.	<00> = 0 <000> = 4	<input type="checkbox"/> D2	<input type="checkbox"/> D2
Must be "0"		<input type="checkbox"/> D1	<input type="checkbox"/> D1

Example:

- A +/- operation not succeeds taxable status and commission status (a = 1), amount in drawer should be declared before Z reporting (b = 4): D10 = 5 (1 + 4).
- key must always be pressed for a finalization (a = 1), not allowing zero or minus subtotal in a transaction (b = 2), not allowing multiple refund operations (c = 4): D9 = 7 (1 + 2 + 4).
- Affecting the result of +/-, %+/%- to an item: D8 = 1.
- Not including commission in net total: D7 = 2.
- Clearing key buffer when a receipt is issued (a = 1), not sounding key catch tone (b = 2), issues post receipts even the original receipt is issued (c = 4): D6 = 7 (1 + 2 + 4).
- D5 – D3 must be 000.
- Using 00 key as 000 key D2 = 4.
- D1 must be 0.

Press

Advanced programmings and registrations

Set code 08 (Fixed total print control)

Description		Selection	Program code	Default value
Print gross sales total (GROSS) on fixed total report.	a	Yes = 0 No = 1	<input type="checkbox"/> (a+b+c) D10	<input type="text" value="0"/> (a+b+c) D10
Print net sales total (NET) on fixed total report.	b	Yes = 0 No = 2		
Print cash in drawer (CAID) on fixed total report.	c	Yes = 0 No = 4		
Print charge in drawer (CHID) on fixed total report.		Yes = 0 No = 2	<input type="checkbox"/> D9	<input type="text" value="5"/> D9
Print check in drawer (CKID) on fixed total report.	a	Yes = 0 No = 1	<input type="checkbox"/> (a+b) D8	<input type="text" value="2"/> (a+b) D8
Print credit in drawer on (CRID(1) ~ (4)) on fixed total report.	b	Yes = 0 No = 4		
Must be "0"			<input type="text" value="0"/> D7	<input type="text" value="7"/> D7
Print RF mode total (RF) on fixed total report.		Yes = 0 No = 4	<input type="checkbox"/> D6	<input type="text" value="3"/> D6
Print the net number of customers (CUST) on fixed total report.	a	Yes = 0 No = 1	<input type="checkbox"/> (a+b) D5	<input type="text" value="6"/> (a+b) D5
Print average sales per customer (AVER) on fixed total report.	b	Yes = 0 No = 2		
Print tax total		Yes = 0 No = 1	<input type="checkbox"/> D4	<input type="text" value="7"/> D4
Print commission 1 total (C-1) on fixed total report.	a	Yes = 0 No = 1	<input type="checkbox"/> (a+b+c) D3	<input type="text" value="7"/> (a+b+c) D3
Print commission 2 total (C-2) on fixed total report.	b	Yes = 0 No = 2		
Print foreign currency cash in drawer (CECA1, CECA2) and check in drawer (CECK1, CECK2) on fixed total report.	c	Yes = 0 No = 4		
Print <MINUS>, <COUPON>, <%-> and mix & match operation net total (DC) on fixed total report.	a	Yes = 0 No = 1	<input type="checkbox"/> (a+b) D2	<input type="text" value="7"/> (a+b) D2
Print total number of <REFUND> operation (RF) on fixed total report.	b	Yes = 0 No = 2		
Print nontaxable totals (NON TAX) on fixed total report.		Yes = 0 No = 1	<input type="checkbox"/> (a+b+c) D1	<input type="text" value="3"/> (a+b+c) D1
Print rounded fractions (ROUND) on fixed total report.	b	Yes = 0 No = 2		
Print number of cancellation (CANCEL) on fixed total report.	c	Yes = 0 No = 4		

Advanced programmings and registrations

Example:

- On the fixed total report, not printing gross sales total (a = 1), not printing net sales total (b = 2), not printing cash in drawer. (c = 4): D10 = 7 (1 + 2 + 4).
- Not printing charge in drawer on fixed total report: D9 = 2.
- On fixed total report, not printing check amount in drawer (a = 1), not printing credit amount in drawer (b = 4): D8 = 5 (1 + 4).
- D7 must be always 0.
- Not printing refunded amount in RF mode on fixed total report: D6 = 4.
- Not printing total number of customers on fixed total report (a = 1), not printing average sales amount per customer (b = 2): D5 = 3 (1 + 2).
- Print tax total : D4 = 0
- On fixed total report, not printing commission 1 amount (a = 1), not printing commission 2 amount (b = 2), not printing amount of foreign currency cash and check (c = 4): D3 = 7 (1 + 2 + 4).
- On fixed total report, not printing net total of <MINUS>, <COUPON>, <%-> etc. (a = 1), not printing <REFUND> and <VOID> amounts (b = 2): D2 = 3 (1 + 2).
- On fixed total report, not printing non-taxable amounts (a = 1), not printing rounded down amount (b = 2), not printing cancelled amount (c = 4): D1 = 7 (1 + 2 + 4).

Press **3** **SUB TOTAL** **0 8 2 2** **SUB TOTAL** **7 2 5 0 4 3 0 7 3 7** **CA / AMT / TEND** **SUB TOTAL**

Advanced programmings and registrations

Set code 09 (Fixed total print control 2)

Description		Selection	Program code	Default value
Print taxable amount 1 total on fixed total report. (TA1)	a	Yes = 0 No = 1	<input type="checkbox"/> (a+b) D10	<input type="checkbox"/> 4 D10
Print tax 1 total on fixed total report. (TX1)	b	Yes = 0 No = 2		
Print taxable amount 2 total on fixed total report. (TA2)	a	Yes = 0 No = 1	<input type="checkbox"/> (a+b) D9	<input type="checkbox"/> 4 D9
Print tax 2 total on fixed total report. (TX2)	b	Yes = 0 No = 2		
Print taxable amount 3 total on fixed total report. (TA3)	a	Yes = 0 No = 1	<input type="checkbox"/> (a+b) D8	<input type="checkbox"/> 7 D8
Print tax 3 total on fixed total report. (TX3)	b	Yes = 0 No = 2		
Print taxable amount 4 total on fixed total report. (TA4)	a	Yes = 0 No = 1	<input type="checkbox"/> (a+b) D7	<input type="checkbox"/> 7 D7
Print tax 4 total on fixed total report. (TX4)	b	Yes = 0 No = 2		
Print taxable amount 5 total on fixed total report. (TA5)	a	Yes = 0 No = 1	<input type="checkbox"/> (a+b) D6	<input type="checkbox"/> 7 D6
Print tax 5 total on fixed total report. (TX5)	b	Yes = 0 No = 2		
Print taxable amount 6 total on fixed total report. (TA6)	a	Yes = 0 No = 1	<input type="checkbox"/> (a+b) D5	<input type="checkbox"/> 7 D5
Print tax 6 total on fixed total report. (TX6)	b	Yes = 0 No = 2		
Print taxable amount 7 total on fixed total report. (TA7)	a	Yes = 0 No = 1	<input type="checkbox"/> (a+b) D4	<input type="checkbox"/> 7 D4
Print tax 7 total on fixed total report. (TX7)	b	Yes = 0 No = 2		
Print taxable amount 8 total on fixed total report. (TA8)	a	Yes = 0 No = 1	<input type="checkbox"/> (a+b) D3	<input type="checkbox"/> 7 D3
Print tax 8 total on fixed total report. (TX8)	b	Yes = 0 No = 2		
Print taxable amount 9 total on fixed total report. (TA9)	a	Yes = 0 No = 1	<input type="checkbox"/> (a+b) D2	<input type="checkbox"/> 7 D2
Print tax 9 total on fixed total report. (TX9)	b	Yes = 0 No = 2		
Print taxable amount 10 total on fixed total report. (TA10)	a	Yes = 0 No = 1	<input type="checkbox"/> (a+b) D1	<input type="checkbox"/> 7 D1
Print tax 10 total on fixed total report. (TX10)	b	Yes = 0 No = 2		

Advanced programmings and registrations

Set code 10 (Print control of taxable amount)

Description	Selection	Program code	Default value
Print taxable amount 1 on receipt/journal.	a Yes = 0 No = 1	<input type="checkbox"/> (a+b+c) D10	<input type="text" value="0"/> D10
Print taxable amount 2 on receipt/journal.	b Yes = 0 No = 2		
Print taxable amount 3 on receipt/journal.	c Yes = 0 No = 4		
Print taxable amount 4 on receipt/journal.	a Yes = 0 No = 1	<input type="checkbox"/> (a+b+c) D9	<input type="text" value="0"/> D9
Print taxable amount 5 on receipt/journal.	b Yes = 0 No = 2		
Print taxable amount 6 on receipt/journal.	c Yes = 0 No = 4		
Print taxable amount 7 on receipt/journal.	a Yes = 0 No = 1	<input type="checkbox"/> (a+b+c) D8	<input type="text" value="0"/> D8
Print taxable amount 8 on receipt/journal.	b Yes = 0 No = 2		
Print taxable amount 9 on receipt/journal.	c Yes = 0 No = 4		
Print taxable amount 10 on receipt/journal.	Yes = 0 No = 1	<input type="checkbox"/> D7	<input type="text" value="0"/> D7
Must be "000000" (six zeros)	a Yes = 0 No = 1	<input type="text" value="0"/> to <input type="text" value="0"/> D6 to D1	<input type="text" value="0"/> to <input type="text" value="0"/> D6 to D1

Set code 14 (Currency exchange)

Description	Selection	Program code	Default value
Monetary mode of CECA1 and CECK1 in fixed total report. CECA: Foreign currency cash in drawer CECK: Foreign currency check in drawer	0 to 9	<input type="checkbox"/> D8	<input type="text" value="0"/> D8
Decimal for CECA1 and CECK1 in fixed total report: Period = 0, Comma = 1	a Period = 0 Comma = 1	<input type="checkbox"/> (a+b+c) D7	<input type="text" value="0"/> (a+b+c) D7
Separator for CECA1 and CECK1 in fixed total report: Comma = 0, Period = 4	b Comma = 0 Period = 4		
Monetary mode of CECA2 and CECK2 in fixed total report.	0 to 9	<input type="checkbox"/> D6	<input type="text" value="0"/> D6
Decimal for CECA2 and CECK2 in fixed total report: Period = 0, Comma = 1	a Period = 0 Comma = 1	<input type="checkbox"/> (a+b) D5	<input type="text" value="0"/> (a+b) D5
Separator for CECA2 and CECK2 in fixed total report: Comma = 0, Period = 4	b Comma = 0 Period = 4		
Always "0000"		<input type="text" value="0"/> to <input type="text" value="0"/> D4 to D1	<input type="text" value="0"/> to <input type="text" value="0"/> D4 to D1

Advanced programmings and registrations

Set code 15 (Printing methods of sales reports)

Description	Selection	Program code	Default value
Department zero skip (Departments of sales amount zero are not printed on sales reports.)	a Yes = 0 No = 1	<input type="checkbox"/> (a+b) D10	<input type="checkbox"/> (a+b) D10
Clerk zero skip (Zero amounted clerks are not printed on sales reports.)	b Yes = 0 No = 2		
Transaction key zero skip (Transaction keys of sales amount zero are not printed on sales reports.)	a Yes = 0 No = 1	<input type="checkbox"/> (a+b+c) D9	<input type="checkbox"/> (a+b+c) D9
PLU zero skip (Zero amounted PLUs are not printed on sales reports.)	b Yes = 0 No = 2		
Hourly sales report skip (Zero amounted time zones are not printed on sales reports.)	c Yes = 0 No = 4		
Group zero skip (Zero amounted groups are not printed on sales reports.)	Yes = 0 No = 1	<input type="checkbox"/> D8	<input type="checkbox"/> D8
Must be "00"		<input type="checkbox"/> <input type="checkbox"/> D7 D6	<input type="checkbox"/> <input type="checkbox"/> D7 D6
Print PLU numbers on the PLU report.	No = 0 Yes = 4	<input type="checkbox"/> D5	<input type="checkbox"/> D5
Print sales ratio on sales reports.	a No = 0 Yes = 1	<input type="checkbox"/> (a+b) D4	<input type="checkbox"/> (a+b) D4
Issue double Z reports.	b No = 0 Yes = 2		
Must be "000"		<input type="checkbox"/> <input type="checkbox"/> <input type="checkbox"/> D3 D2 D1	<input type="checkbox"/> <input type="checkbox"/> <input type="checkbox"/> D3 D2 D1

Set code 16 (Printing methods of grand total)

Description	Selection	Program code	Default value
Print range of consecutive number on fixed total report.	No = 0 Yes = 1	<input type="checkbox"/> D7	<input type="checkbox"/> D7
Must be "00111"		<input type="checkbox"/> <input type="checkbox"/> <input type="checkbox"/> <input type="checkbox"/> <input type="checkbox"/> D6 D5 D4 D3 D2	<input type="checkbox"/> <input type="checkbox"/> <input type="checkbox"/> <input type="checkbox"/> <input type="checkbox"/> D6 D5 D4 D3 D2
Print grand total on daily sales reset (Z) report.	Yes = 0 No = 1	<input type="checkbox"/> D1	<input type="checkbox"/> D1

Advanced programmings and registrations

Set code 17 (Date/time printing on journals/receipts)

Description	Selection	Program code	Default value
Print date on journal.	a Yes = 0 No = 2	<input type="checkbox"/> (a+b) D4	<input type="text" value="0"/> (a+b) D4
Print consecutive number on receipt/journal.	b Yes = 0 No = 4		
Print time on receipt.	a Yes = 0 No = 1	<input type="checkbox"/> (a+b) D3	<input type="text" value="0"/> (a+b) D3
Print time on journal.	b Yes = 0 No = 2		
Must be "0"		<input type="text" value="0"/> D2	<input type="text" value="0"/> D2
Alert electronic journal near end/end.	a No = 0 Yes = 1	<input type="checkbox"/> (a+b+c) D1	<input type="text" value="0"/> D1
Reset electronic journal (internal) after issuing daily reset report.	b Yes = 0 No = 2		
Store sales data and electronic journal data in SD card.	c No = 0 Yes = 4		

Set code 19 (Double height character printing on receipts)

Description	Selection	Program code	Default value
Print receipt in double height characters	No = 0 Yes = 1	<input type="checkbox"/> D7	<input type="text" value="0"/> D7
Must be "000000" (six zeros)		<input type="text" value="0"/> <input type="text" value="0"/> <input type="text" value="0"/> <input type="text" value="0"/> <input type="text" value="0"/> <input type="text" value="0"/> D6 D5 D4 D3 D2 D1	<input type="text" value="0"/> <input type="text" value="0"/> <input type="text" value="0"/> <input type="text" value="0"/> <input type="text" value="0"/> <input type="text" value="0"/> D6 D5 D4 D3 D2 D1

Set code 21 (Printing methods of messages)

Description	Selection	Program code	Default value
Print graphic type logo. (If "No" is selected, character logo will be printed.)	No = 0 Yes = 2	<input type="checkbox"/> D10	<input type="text" value="2"/> D10
Must be "000"		<input type="text" value="0"/> <input type="text" value="0"/> <input type="text" value="0"/> D9 D8 D7	<input type="text" value="0"/> <input type="text" value="0"/> <input type="text" value="0"/> D9 D8 D7
Print commercial message on receipts in REG/RF mode.	a No = 0 Yes = 1	<input type="checkbox"/> (a+b) D6	<input type="text" value="0"/> (a+b) D6
Print bottom message on receipts in REG/RF mode.	b No = 0 Yes = 2		
Must be "0000"		<input type="text" value="0"/> <input type="text" value="0"/> <input type="text" value="0"/> <input type="text" value="0"/> D5 D4 D3 D2	<input type="text" value="0"/> <input type="text" value="0"/> <input type="text" value="0"/> <input type="text" value="0"/> D5 D4 D3 D2
Print Australian GST MOF message.	No = 0 Yes = 4	<input type="checkbox"/> D1	<input type="text" value="0"/> D1

Advanced programmings and registrations

Set code 25 (Entry restriction)

Description	Selection	Program code	Default value
Restrict (to 0 or 5) to the last digit for amount tender.	a No = 0 Yes = 1	<input type="checkbox"/>	<input type="checkbox"/> 0
Restriction (to 0 or 5) to the last digit for <input type="checkbox"/> CA/AMT/TEND, <input type="checkbox"/> RA, <input type="checkbox"/> PO, money declaration amount.	b No = 0 Yes = 4	(a+b) D1	(a+b) D1

D1 becomes "4", after activating Australian GST.

Set code 27 (Clerk operation selections)

Description	Selection	Program code	Default value
Allow clerk functions.	No = 0 Yes = 4	<input type="checkbox"/> D9	<input type="checkbox"/> 0 D9
Must be "00000000"		<input type="checkbox"/> 0 to <input type="checkbox"/> 0 D8 to D1	<input type="checkbox"/> 0 to <input type="checkbox"/> 0 D8 to D1

Set code 28 (Euro 1)

Description	Selection	Program code	Default value
Define Euro as the main currency.	Yes = 0 No = 1	<input type="checkbox"/> D10	<input type="checkbox"/> 0 D10
Select rounding option: Round off = 0, Cut off = 1, Round up = 2	0,1 or 2	<input type="checkbox"/> D9	<input type="checkbox"/> 0 D9
Exchange rate (in 6 digits)	Exchange rate	<input type="checkbox"/> to <input type="checkbox"/> D8 to D3	<input type="checkbox"/> 0 to <input type="checkbox"/> 0 D8 to D3
Decimal point position of exchange rate: Integer only = 0, 1st decimal place = 1, 2nd decimal place = 2, 3rd decimal place = 3, 4th decimal place = 4, 5th decimal place = 5, 6th decimal place = 6 Example: (D8 ~ D2): 1 Euro = 1.977DM; set "0019773" 1 Euro = 1957.77319 Lit; set "1957772"	0 to 6	<input type="checkbox"/> D2	<input type="checkbox"/> 0 D2
Must be "0"		<input type="checkbox"/> 0 D1	<input type="checkbox"/> 0 D1

Example 1: To set Euro as main currency, rounding off, exchange rate €1.00 = DM 1.9558

3 SUB TOTAL 2 8 2 2 SUB TOTAL 0 0 0 1 9 5 5 8 4 0 CA/AMT/TEND SUB TOTAL

Example 2: To set Euro as sub currency, rounding up, exchange rate €1.00 = £0.8573

3 SUB TOTAL 2 8 2 2 SUB TOTAL 1 2 0 0 8 5 7 3 4 0 CA/AMT/TEND SUB TOTAL

Advanced programmings and registrations

Set code 29 (Euro 2)

Description	Selection	Program code	Default value
ADD mode of sub currency: 0. = 0, 0.0 = 1, 0.00 = 2, 0.000 = 3	0 to 3	<input type="checkbox"/> D10	<input checked="" type="checkbox"/> D10
Apply rounding for sub currency. * No rounding = 0, IF1 = 1, IF2 = 2, Danish = 3, Norwegian = 4, Singaporean = 5, Finnish = 6, Australian = 7, South African = 8	0 to 8	<input type="checkbox"/> D9	<input checked="" type="checkbox"/> D9
Must be "0"		<input checked="" type="checkbox"/> D8	<input checked="" type="checkbox"/> D8
Print tendered amount in sub currency converted to main currency.	a No = 0 Yes = 1	<input type="checkbox"/> (a+b+c) D7	<input checked="" type="checkbox"/> (a+b+c) D7
Selection of the currency of subtotal printout: 1 Main currency only, 2 Main and sub currency	b ① = 0 ② = 2		
Print total in sub currency by double sized letter.	c No = 0 Yes = 4		
Selection of the currency of change: 1 Main currency only, 2 Sub currency	a ① = 0 ② = 1	<input type="checkbox"/> (a+b+c) D6	<input checked="" type="checkbox"/> (a+b+c) D6
Print the cash in drawer in sub currency on fixed total reports. (If the cash in drawer of main currency is skipped, this line is also skipped.)	b No = 0 Yes = 2		
Display symbols of sub currency: 1 e (Euro), 2 l (Local)	c ① = 0 ② = 4		
Restrict (to 00, 25, 50, 75) on last two digits for amount ten- dered: 1 Main currency, 2 Sub currency (It is necessary to set this restriction to <CASH> key.)	a ① = 0 ② = 1	<input type="checkbox"/> (a+b+c) D5	<input checked="" type="checkbox"/> (a+b+c) D5
Print rounding total of sub currency on fixed totalizer report.	b No = 0 Yes = 2		
Restrict the last digit for sub currency monetary amount entries to 0 or 5.	c No = 0 Yes = 4		
Selection of the change amount printout: 1 Main and sub currency, 2 Dependent upon D6 -a of this worksheet	a ① = 0 ② = 1	<input type="checkbox"/> (a+b) D4	<input checked="" type="checkbox"/> (a+b) D4
Calculation method of change amount in sub currency: 1 Convert the change amount in main currency into sub cur- rency. 2 Subtract the equivalent value of subtotal amount in sub cur- rency from the equivalent value of the tendered amount in sub currency.	b ① = 0 ② = 2		
Must be "000"	000	<input checked="" type="checkbox"/> <input checked="" type="checkbox"/> <input checked="" type="checkbox"/> D3 D2 D1	<input checked="" type="checkbox"/> <input checked="" type="checkbox"/> <input checked="" type="checkbox"/> D3 D2 D1

Advanced programmings and registrations

Set code 30 (Thermal printer control)

Description	Selection	Program code	Default value
Select POP image: Effective when D5 is 1; always print same image.	Image1 = 1 Image2 = 2 Image3 = 3 Image4 = 4 Image5 = 5	<input type="checkbox"/> D6	<input type="text" value="0"/> D6
Print condition of POP message. No printing: 0 ① Always print the same POP message; 1 ② Print POP when particular item is registered; 2 ③ Print POP according to the amount; 3	No = 0 ① = 1 ② = 2 ③ = 3	<input type="checkbox"/> D5	<input type="text" value="0"/> D5
Journal compressed print (print half height characters)	Yes = 0 No = 1	<input type="checkbox"/> D4	<input type="text" value="0"/> D4
Must be "000"		<input type="checkbox"/> <input type="checkbox"/> <input type="checkbox"/> D3 D2 D1	<input type="text" value="0"/> <input type="text" value="0"/> <input type="text" value="0"/> D3 D2 D1

Set code 34 (Backlight control)

Description	Selection	Program code	Default value
Backlight	Functions = 0 Not functions = 1	<input type="checkbox"/> D4	<input type="text" value="0"/> D4
Must be "0"		<input type="text" value="0"/> D3	<input type="text" value="0"/> D3
Backlight off timer (01~59 minutes, "00" means always on.)		<input type="text" value=""/> <input type="text" value=""/> D2 D1	<input type="text" value="2"/> <input type="text" value="0"/> D2 D1

Advanced programmings and registrations

Programming functions of departments and PLUs in a lump

There are two methods to set functions of departments or PLUs which are programming at once and programming individual functions.

Programming department functions in a lump

This method programs function of a department at one time.

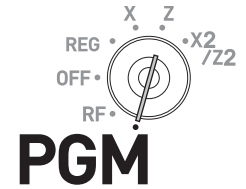

Step	Operation
1 Turn the Mode switch to PGM position and select [System Setting] then press key.
2 Enter 3 and press key to set the register in the programming mode.	3
3 You can skip this step if you program in departments 01 through 30. If you wish to program in departments 31 through 60, press key.	
4 Referring following table, input 12- digit program code.	<input type="text"/> <input type="text"/> <input type="text"/> <input type="text"/> [Program code (12 digits)]
5 Press the department key you wish to program	<input type="text"/> 1 For example, programming in dept. 26.
6 Repeat steps 3 through 5 if you wish to program functions in another departments.	
7 Press key to complete the program.	

Example:

Programming department 31 as;

- Normal item: D12 = 0.
- D11 through D8 must be 0000.
- US taxable status 1 (a = 1) and 2 (b = 2): D7 = 3 (1 + 2)
- Allowing zero unit price (a = 1), not allowing negative unit price (b = 0), hash item (c = 4): D6 = 5 (1 + 0 + 4).
- D5 must always be 0.
- Limiting minimum entry digit: 3 digits: D4 = 3.
- As this example is for setting functions in a department, D3 should be 0.
- Applying commission 1 (a = 1), not applying commission 2 (b = 0): D2 = 1 (1 + 0).
- D1 must always be 0.

Press **3** **0 0 0 0 0 3 5 0 3 0 1 0** **1**

Advanced programmings and registrations

Department and PLU lump set code

Description			Selection	Program code	Default value
Single item sales: Normal item = 0, Single item = 3			0 or 3	<input type="checkbox"/> D12	<input type="checkbox"/> D12
Must be "000"			000	<input type="checkbox"/> <input type="checkbox"/> <input type="checkbox"/> D11 D10 D9	<input type="checkbox"/> <input type="checkbox"/> <input type="checkbox"/> D11 D10 D9
Taxable status	For Singapore	D8 must be 0	a 0	<input type="checkbox"/> D8	<input type="checkbox"/> D8
		Taxable status 1	a No = 0 Yes = 1	<input type="checkbox"/> (a+b+c) D7	<input type="checkbox"/> D7
		Taxable status 2	b No = 0 Yes = 2		
		Taxable status 3	c No = 0 Yes = 4		
	For India	Taxable 1 & 2 = 01, Taxable 3 & 4 = 02, Taxable 5 & 6 = 03, Taxable 7 & 8 = 04, Taxable 9 & 10 = 05		<input type="checkbox"/> <input type="checkbox"/> D8 D7	
For other countries	Non tax = 00, Taxable 1 = 01, Taxable 2 = 02, Taxable 3 = 03, Taxable 4 = 04, Taxable 5 = 05, Taxable 6 = 06, Taxable 7 = 07, Taxable 8 = 08, Taxable 9 = 09, Taxable 10 = 10, All taxable = 99 (only for transaction keys)		<input type="checkbox"/> <input type="checkbox"/> D8 D7	<input type="checkbox"/> <input type="checkbox"/> D8 D7	
Enable zero unit price.		a	No = 0 Yes = 1	<input type="checkbox"/> (a+b+c) D6	<input type="checkbox"/> (a+b+c) D6
Enable negative price.		b	No = 0 Yes = 2		
Hash item		c	No = 0 Yes = 4		
Department only. POP print file. Effective when set code 30's D5 = 2 (print when particular item is registered).			Image1 = 1 Image2 = 2 Image3 = 3 Image4 = 4 Image5 = 5	<input type="checkbox"/> D5	<input type="checkbox"/> D5
Low digit limitation (LDL) for manually entered unit price.			Number of digits	<input type="checkbox"/> D4	<input type="checkbox"/> D4
Open PLU (only for PLU)			No = 0 Yes = 4	<input type="checkbox"/> D3	<input type="checkbox"/> D3
Commission 1 (give commission on items)		a	No = 0 Yes = 1	<input type="checkbox"/> (a+b) D2	<input type="checkbox"/> (a+b) D2
Commission 2		b	No = 0 Yes = 2		
Must be "0"				<input type="checkbox"/> D1	<input type="checkbox"/> D1

Advanced programmings and registrations

Programming PLU functions in a lump

This method programs functions of a PLU at one time.

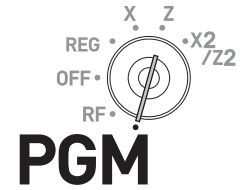

Step

- 1 Turn the Mode switch to PGM position and select [System Setting] then press key.
- 2 Enter **3** and press key to set the register in the programming mode.
- 3 Enter four-digit PLU number then press key.
- 4 Referring the table in the previous section, input 12- digit program code.
- 5 Press key.
- 6 Repeat steps 3 through 5 if you wish to program functions in another PLU.
- 7 Press key to complete the program.

Operation



For example, to program PLU number fourteen.

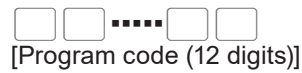

Programming functions of departments and PLUs individually

Programming functions of departments individually

This part explains programming methods of each function of departments individually.



Step

- 1** Turn the Mode switch to PGM position and select [System Setting] then press key.
- 2** Enter **3** and press key to set the register in the programming mode.
- 3** Referring the following table, enter two-digit set code you wish to program followed by two 6s. The “66” is the identification code for individual programming of departments and PLUs. Then press key.
- 4** You can skip this step if you program in departments 01 through 30. If you wish to program in departments 31 through 60, press key.
- 5** Referring the following table, enter program code and press the department key in which you wish to set.
- 6** If you wish to set the same function in another department, press the corresponding dept. key.
- 7** Repeat steps 4 and 5 to set another function in another department.
- 8** Press key to complete the program.

Operation



This example is for linking dept. 03 to item group 123 assuming set code 11 has been entered in step 3 and key is not pressed in step 4.



This example is for setting the same linking group in dept. 04.



Advanced programmings and registrations

Set code table

Set code	Description		Selection	Program code
03	Taxable status	D8 must be 0	0	<input type="text" value="0"/> D2
		For Singapore	a	<input type="checkbox"/> (a+b+c) D1
		Taxable status 1	No = 0 Yes = 1	
		Taxable status 2	No = 0 Yes = 2	
	For India	c	No = 0 Yes = 4	<input type="text"/> D2 D1
For other countries	Taxable 1 & 2 = 01, Taxable 3 & 4 = 02, Taxable 5 & 6 = 03, Taxable 7 & 8 = 04, Taxable 9 & 10 = 05	00 to 10	<input type="text"/> D2 D1	
04	Open PLU (Only for PLU)	No = 0 Yes = 4	<input type="checkbox"/>	
05	Allow unit price 0	a	No = 0 Yes = 1	<input type="checkbox"/> (a+b+c)
	Allow negative unit price.	b	No = 0 Yes = 2	
	Hash item	c	No = 0 Yes = 4	
07	Minimum digit of manual input unit price	Number of minimum digit	<input type="text"/>	
09	Commission 1	a	No = 0 Yes = 1	<input type="checkbox"/> (a+b)
	Commission 2	b	No = 0 Yes = 2	
11	Linking group (000 to 999)	000 to 999	<input type="text"/> D7 D6 D5	
	Must be 0	0	<input type="text" value="0"/> D4	
	Linking dept. (000 to 999) (Only for PLU)	000 to 999	<input type="text"/> D3 D2 D1	
15	Maximum amount of manual input unit price (up to 9999.99)		<input type="text"/> D6 D5 D4 D3 D2 D1	
18	Single item control: Normal item = 0, Single item = 3	0 or 3	<input type="checkbox"/>	

Example: To program dept. 02 to allow manual input unit price up to •99.00.

3 **1 5 6 6** **9 9 0 0**

Advanced programmings and registrations

Programming functions of PLUs individually

This part explains programming methods of each function of PLUs individually.

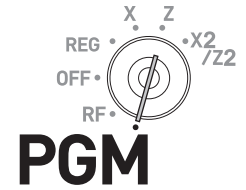

Step	Operation
<p>1 Turn the Mode switch to PGM position and select [System Setting] then press key.</p>
<p>2 Enter 3 and press key to set the register in the programming mode.</p>	3
<p>3 Referring the tables in the proceeding section, enter two-digit set code you wish to program followed by two 6s. The “66” is the identification code for individual programming of departments and PLUs. Then press key.</p>	6 6 (set code)
<p>4 Enter PLU number you wish to set and press key.</p>	0 0 0 5 This example is for setting a program in PLU 0005.
<p>5 Referring the table in the preceding section, enter program code and press key.</p> (Program code)
<p>6 If you wish to set the same program code in the next PLU number, press key again.</p> <p>Perform step 5 if you wish to set another program code to the next PLU number.</p> <p>To program in another PLU number (not next PLU number), repeat steps 4 and 5.</p>	
<p>7 Press key to complete the settings.</p>	

Example 1: To set PLU 0001 as “Open PLU”.





Press **3** **0** **4** **6** **6** **0** **0** **0** **1** **4**

Example 2: To set PLU0012 to link item group 12 and dept. 04.

Press **3** **1** **1** **6** **6** **0** **0** **1** **2** **0** **1** **2** **0** **0** **0** **4**



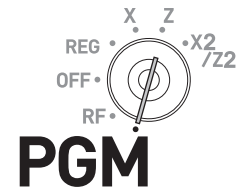

Advanced programmings and registrations

Programming functions of transaction keys

This section explains how you can program functions in each transaction keys such as ,  or  keys. For example, programming  key to force entry of tendered amount.



Step

- 1 Turn the Mode switch to PGM position and select [System Setting] then press  key.
- 2 Enter  and press  key to set the register in the programming mode.
- 3 Referring the following tables, enter the program code then press corresponding transaction key.
- 4 If you wish to program another transaction key, return to step 3.
- 5 Press  key to complete the program.

Operation

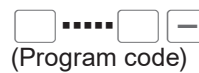

The above example is for programming minus key.



Advanced programmings and registrations

Program code tables

NOTE Default value of all the program codes are “0”.

Program code for CA / AMT / TEND, CH and CHK keys.

Description		Selection	Program code
Restrict to 00/50 on last two digits for amount tendered (Only for <CASH> in Danish rounding)		No = 0 Yes = 4	<input type="checkbox"/> D10
Always “00”			<input type="checkbox"/> <input type="checkbox"/> D9 D8
Prohibit partial payment.	a	No = 0 Yes = 1	<input type="checkbox"/> (a+b+c) D7
Prohibit tendered amount entry	b	No = 0 Yes = 2	
Force to enter tendered amount.	c	No = 0 Yes = 4	
Print breakdown of VAT. (Option for Single item or Currency exchange (including partial tendering foreign currency).)		No = 0 Yes = 1	<input type="checkbox"/> D6
French food coupon	a	No = 0 Yes = 1	<input type="checkbox"/> (a+b) D5
Perform Finnish rounding.	b	No = 0 Yes = 4	
Maximum amount for subtotal and tendered amount. e.g.) •90.00, D4 = 9, D3 = 3		D4: Maximum value (0 ~ 9)	<input type="checkbox"/> <input type="checkbox"/> D4 D3
		D3: Number of zeros (0 ~ 9)	
Maximum amount of change due.		Maximum value (0 ~ 9)	<input type="checkbox"/> <input type="checkbox"/> D2 D1
		Number of zeros (0 ~ 9)	

Example 1: To set CA / AMT / TEND key as prohibiting partial payment (a = 1), not prohibiting tendered amount entry (b = 0), and forcing to enter tendered amount (c = 4): D7 = 5.

Press

Advanced programmings and registrations

Program code for RA and PO keys

Description	Selection	Program code
Maximum amount. e.g.) *100.00; D4 = 1, D3 = 4.	Maximum value (0 ~ 9)	<input type="checkbox"/> <input type="checkbox"/> D4 D3
	Number of zeros (0 ~ 9)	
Must be "00"	00	<input type="checkbox"/> <input type="checkbox"/> D2 D1

Example: To set PO key not allowing to enter more than *9.00.

Press PO

Program code for - and CPN keys

Description		Selection	Program code	
Taxable status	D8 must be 0	0	<input type="checkbox"/> <input type="checkbox"/> D8	
	For Singapore	Taxable status 1	a	No = 0 Yes = 1
		Taxable status 2	b	No = 0 Yes = 2
		Taxable status 3	c	No = 0 Yes = 4
	For India	Taxable 1 & 2 = 01, Taxable 3 & 4 = 02, Taxable 5 & 6 = 03, Taxable 7 & 8 = 04, Taxable 9 & 10 = 05	00 to 10	<input type="checkbox"/> <input type="checkbox"/> D8 D7
For other countries	Non tax = 00, Taxable 1 = 01, Taxable 2 = 02, Taxable 3 = 03, Taxable 4 = 04, Taxable 5 = 05, Taxable 6 = 06, Taxable 7 = 07, Taxable 8 = 08, Taxable 9 = 09, Taxable 10 = 10, All taxable = 99 (only for transaction keys)	00 to 10	<input type="checkbox"/> <input type="checkbox"/> D8 D7	
Allow credit balance.		No = 0 Yes = 1	<input type="checkbox"/> D6	
Must be "00"		00	<input type="checkbox"/> <input type="checkbox"/> D5 D4	
Maximum digit of manual input unit price (Setting "9" programs NOT allowing manual entry.)		Number of digit	<input type="checkbox"/> D3	
Give commission 1	a	No = 0 Yes = 1	<input type="checkbox"/> (a+b) D2	
Give commission 2	b	No = 0 Yes = 2		
Must be "0"		0	<input type="checkbox"/> D1	

Advanced programmings and registrations

Program code for key

Description		Selection	Program code
Taxable status	D8 must be 0	0	<input type="text" value="0"/> D8
	Taxable status 1	a	No = 0 Yes = 1
	Taxable status 2	b	No = 0 Yes = 2
	Taxable status 3	c	No = 0 Yes = 4
	For Singapore		<input type="text"/> (a+b+c) D7
For India	Taxable 1 & 2 = 01, Taxable 3 & 4 = 02, Taxable 5 & 6 = 03, Taxable 7 & 8 = 04, Taxable 9 & 10 = 05	00 to 10	<input type="text"/> <input type="text"/> D8 D7
For other countries	Non tax = 00, Taxable 1 = 01, Taxable 2 = 02, Taxable 3 = 03, Taxable 4 = 04, Taxable 5 = 05, Taxable 6 = 06, Taxable 7 = 07, Taxable 8 = 08, Taxable 9 = 09, Taxable 10 = 10, All taxable = 99 (only for transaction keys)	00 to 99	<input type="text"/> <input type="text"/> D8 D7
Prohibit manual rate entry.		No = 0 Yes = 2	<input type="text"/> D6
Rounding: Round off = 0, Cut off = 1, Round up = 2		0, 1 or 2	<input type="text"/> D5
Must be "00"		00	<input type="text"/> <input type="text"/> D4 D3
Give commission 1	a	No = 0 Yes = 1	<input type="text"/> (a+b)D2
Give commission 2	b	No = 0 Yes = 2	
Must be "0"		0	<input type="text"/> D1

Program code for key

Description	Selection	Program code
Allow mode change or clerk change after  key operation as first transaction. (Only for non-add function)	Yes = 0 No = 1	<input type="text"/> D7
Must be "000000"	000000	<input type="text"/> <input type="text"/> <input type="text"/> <input type="text"/> <input type="text"/> <input type="text"/> D6 D5 D4 D3 D2 D1

Program code for key

Description	Selection	Program code
Multiplication procedure ① Quantity × Amount, ② Amount × Quantity	① = 0 ② = 1	<input type="text"/> D6
Roundings: Round off = 0, Cut off = 1, Round up = 2	0, 1, or 2	<input type="text"/> D5
Must be "0000"	0000	<input type="text"/> <input type="text"/> <input type="text"/> <input type="text"/> D4 D3 D2 D1

Advanced programmings and registrations

Program code for CE key

Description		Selection	Program code
Define foreign currency symbol (0, 1, 2, 3, or 4). See "Setting symbol characters" on page E-68. Setting "0" defines the local currency.		0 to 4	<input type="checkbox"/> D7
Define foreign currency totalizer (0, 1, 2) 0 is treated as 1		0, 1 or 2	<input type="checkbox"/> D6
Roundings: Round off = 0, Cut off = 1, Round up = 2		0, 1 or 2	<input type="checkbox"/> D5
Must be "0"		0	<input checked="" type="checkbox"/> D4
ADD mode 0. = 0, 0.0 = 1, 0.00 = 2, 0.000 = 3		0 to 9	<input type="checkbox"/> D3
Decimal point symbol	a	Decimal point = 0	<input type="checkbox"/> (a+b)D2
		Comma = 1	
Separator symbol	b	Comma = 0	
		Decimal point = 4	
Must be "0"		0	<input checked="" type="checkbox"/> D1

Advanced programmings and registrations

Programming further clerk functions

This section explains how you can set further programming for clerks such as setting the register in training mode or setting commission rates given to clerks. In the training mode, the register operates normally but the results will not be stored in the memory. You can use this feature for getting to know the operations of the cash register for yourself or for newly hired clerks.

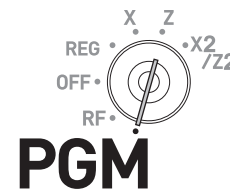

Step	Operation
1 Turn the Mode switch to PGM position and select [System Setting] then press key.
2 Enter 3 and press key to set the register in the programming mode.	3
3 Enter 2 -digit clerk number followed by 07. The "07" is the identification code for further program of clerks. Then press o key. The example on the right is for programming to clerk number 10.	1 0 0 7 (Clerk no.)
4 Referring the following tables, input the set code you wish to program and press key. The example on the right is for setting a commission rate.	6 8 (set code)
5 Enter the program code and press key. The example on the right is for setting 8.5% to commission rate 1 and 5% to commission 2.	0 8 5 0 0 5 0 0 (program code)
6 If you wish to set the same program to the next clerk number, perform the step 5 again. When you set to another clerk (not next clerk number), repeat steps 3 through 5.	
7 Press key to complete the settings.	

Set code 67 (Training mode)

Description	Selection	Program code
Training mode	No = 0 Yes = 1	<input type="checkbox"/> D6
Must be "0000"		0 0 0 0 D5 D4 D3 D2
Registration operable	Yes = 0 No = 1	<input type="checkbox"/> D1

Example 1: To set the clerk number 15 as a clerk being trained.

Press **3** **1 5 0 7** **1 0 0 0 0 0 0**

Set code 68 (Commission rates)

Description	Selection	Program code
Commission rate 1 (integer)	00 to 99	<input type="checkbox"/> <input type="checkbox"/> D8 D7
Commission rate 1 (decimal)	00 to 99	<input type="checkbox"/> <input type="checkbox"/> D6 D5
Commission rate 2 (integer)	00 to 99	<input type="checkbox"/> <input type="checkbox"/> D4 D3
Commission rate 2 (decimal)	00 to 99	<input type="checkbox"/> <input type="checkbox"/> D2 D1

Printing programmed data

After programs have been set, you can print the programmed data.

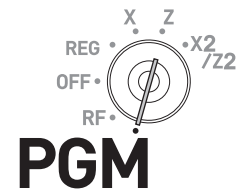

To print programmed unit price or percentage (other than PLU)

Step

- 1 Turn the Mode switch to PGM position and select [System Setting] then press key.
- 2 Enter **1** and press key.
- 3 Press key again. The printer starts to print preset data.

Printout





P01.....		1
CASH	@0.00	
-	@1.00	2
%-	10%	
DEPT001	0001-05	3
	@1.00	4
DEPT002	0002-05	
	@2.00	

- 1: Program read symbol
- 2: Transaction key unit price or rate
- 3: Department descriptor/rec-#/05
- 4: Unit price

Advanced programmings and registrations

To print programmed characters (except PLUs)

Step

- 1 Turn the Mode switch to PGM position and select [System Setting] then press  key.
- 2 Enter  and press  key.
- 3 Press  key again. The printer starts to print preset data.

Printout



P02.....		1
GROSS	0001-01	
NET	0002-01	
CAID	0003-01	2
	0004-01	
	0005-01	
CASH	0001-02	
CHECK	0002-02	3
	0003-02	
	0004-02	
DEPT001	0001-05	
DEPT002	0002-05	4
	0003-05	
	0004-05	
GROUP01	0001-06	
GROUP02	0002-06	5
GROUP03	0003-06	
	0004-06	
C01	0001-07	
C02	0002-07	6
	0003-07	
	0004-07	
GT	0001-20	7
. @No/ ** /		
NoCT @LB *QT	0002-23	8
Y- CUCV	0003-23	
	0001-24	
FIX		
TRANS	0002-24	9
	0003-24	
	0004-24	
DAILY X	0001-29	10
PERIODIC 1X	0002-29	
PERIODIC 2X	0003-29	
	0004-29	
0001-32		
YOUR RECEIPT		11
0002-32		
THANK YOU		
0001-39		
CHARACTER RECALL*****		12

- 1: Program read symbol
- 2: Fix total character
- 3: Transaction key character
- 4: Department character
- 5: Group character
- 6: Clerk character
- 7: GT character
- 8: Special character
- 9: Report header character
- 10: Batch X/Z character
- 11: Receipt message
- 12: Text recall character

Advanced programmings and registrations

To print general programming (except PLUs)

Step

- 1 Turn the Mode switch to PGM position and select [System Setting] then press  key.
- 2 Enter **3** and press  key.
- 3 Press  key again. The printer starts to print preset data.

Printout

P03.....		1
CASH	0001-02	
	00000000000000	2
CHECK	0002-02	3
	00000000000000	4
FD	0003-02	
	00000000000000	
DEPT001	0001-05	5
	00000000000000	6
11-66	00000000	7
15-66	@1.23	8
	0002-05	
C01	0001-07	9
	0000010001	10
67	0000000000	11
68	00000000	12
	0001-09	
	00:00 -> 01:00	
	0002-09	13
	01:00 -> 02:00	
	02:00 -> 03:00	
0001-22	2200000000	
0002-22	0000000000	14
0003-22	0000000000	
0001-28		
0002-28		
0001-25		
TX1	10.25%	15
TX1	0000	
TX1	5003	
DAILY X	0001-29	16
00	11-12-17-15-00	
	00-00-00-00-00	
PERIODIC	1X 0002-29	

- 1: Program read symbol
- 2: Transaction key program
- 3: Key character/rec-#/file-#
- 4: Key program
- 5: Department program/Key character/rec-#/file-#
- 6: Key program
- 7: Address code 11 program
- 8: Address code 15 program
- 9: Clerk program/Clerk name/rec-#/file-#
- 10: Check #/secret-#
- 11: Compulsory
- 12: Commission rate
- 13: Time range program
- 14: General control program
- 15: Tax table
- 16: Batch X/Z program

Advanced programmings and registrations

Printout

0001-30 NET	0001-01 0020-01	17
0001-38 REG1	000001 204-000	18
1	001-000	19
2	002-000	
DEPT001	026-051	
CASH	013-001	
0001-62	000000 00000000000000 0000000000	20
MC#01	0001-91 00000000	
0001-98	00000000000000	21
0002-98	00000000000000	

- 17: Clerk detail link program
- 18: Arrangement program/Rec-#/file-#/arrange no.
- 19: Key descriptor/rec-#/file-#
- 20: Scheduler program
- 21: I/O parameter table

To print preset unit price of PLU

Step

- 1 Turn the Mode switch to PGM position and select [System Setting] then press key.
- 2 Enter **6** and press key to set the register in the programming mode.
- 3 Enter **1 0 4** and press key.
- 4 Enter starting PLU number and press key. For example, if you wish to print from PLU number 0001, input **0 0 0 1** .
- 5 Enter the last PLU number and press key. For example, if you wish to print up to PLU number 0884, input **0 8 8 4** .

Printout





P01.....	1
#0001 - #0884	2
PLU0001 0001-04	3
@1.00	4
PLU0002 0002-04	
@2.00	

- 1: Program read symbol
- 2: Range of PLU No.
- 3: PLU name/rec-#/04
- 4: Unit price

Advanced programmings and registrations

To print preset characters of PLU

Step

- 1 Turn the Mode switch to PGM position and select [System Setting] then press  key.
- 2 Enter **6** and press  key to set the register in the programming mode.
- 3 Enter **2 0 4** and press  key.
- 4 Enter starting PLU number and press  key.
- 5 Enter the last PLU number and press  key.

Printout





```

P02..... 1
      #0001 - #0010 2
PLU0001      0001-04 3
PLU0002      0002-04
PLU0003      0003-04
    
```

- 1: Program 2 mode symbol
- 2: Range of PLU No.
- 3: PLU character

To print PLU programmings

Step

- 1 Turn the Mode switch to PGM position and select [System Setting] then press  key.
- 2 Enter **6** and press  key to set the register in the programming mode.
- 3 Enter **3 0 4** and press  key.
- 4 Enter starting PLU number and press  key.
- 5 Enter the last PLU number and press  key.

Printout

```

P03..... 1
      #0001 - #0010 2
PLU0001      0001-04 3
                0000000000000000 4
11-66                000000 5
13-66      <- 0001-28 6
14-66                0
15-66                @1234.56 7
PLU0003      0002-04
    
```

- 1: Program 3 mode symbol
- 2: Range of PLU No.
- 3: PLU name/rec-#/file-#
- 4: Address code 01 ~ 10, 18 program
- 5: Address code 11 program
- 6: Address code 13 program
- 7: Address code 15 program

Advanced programmings and registrations

Printing various sales reports

You can print categorized sales reports such as PLU sales report, item group sales report, hourly sales report etc.

NOTE

- Please do not perform the reset (Z) report during the business hour as it clears stored sales data from the memory.
- Please see page E-49 for printout sample of a daily report.

Printing various sales reports

The followings are the example operation for printing an electronic journal (EJ) of February 28, 2018.

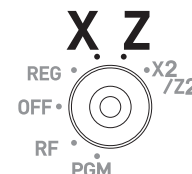

Step

1 Turn the Mode switch to X or Z position. The display shows the top menu of sales reports.

2 Using or keys select the report you wish to obtain. The example on the right is for selecting electronic journal. As it is the lowest column, [EJ] is hidden from the default top menu. Select it by keep pressing key.

3 Input year, month, and day from ten key pad. The journal of assigned date will be printed if you press key.

Display

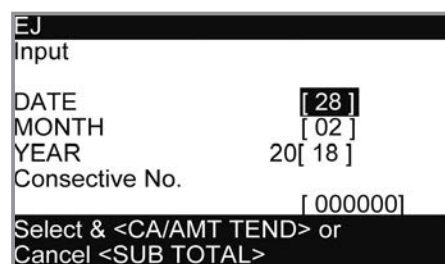
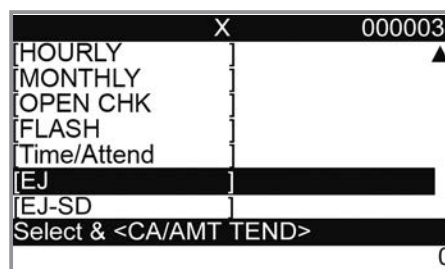
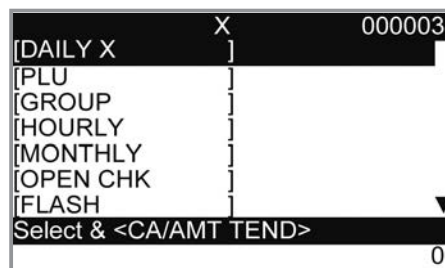

Advanced programmings and registrations

■ PLU sales report

X	PLU		0000014	1
				2
	PLU0001		17	3
	0.53%		·17.00	4
	#0001			5
	PLU0100		42	
	1.03%		·69.00	
	#0100			

	TL		188.61	6
			·516.10	7

- 1 Read symbol/report title
- 2 Report code
- 3 PLU name/Quantity
- 4 Sales ratio/PLU amount
- 5 PLU code
- 6 Total Quantity
- 7 Total amount

■ Item group sales report

X	GROUP		0000016	1
				2
	GROUP01		203.25	3
	33.87%		·1,108.54	4
	GROUP02		183	
	40.58%		·1,327.80	
	GROUP03		12	
	0.40%		·13.25	
	GROUP99		13	
	0.54%		·17.80	

	TL		862	5
			·3,272.00	6

- 1 Read symbol/report title
- 2 Report code
- 3 Group No./Quantity
- 4 Sales ratio/group amount
- 5 Total quantity of group
- 6 Group total amount

■ Hourly sales report

X	HOURLY		0000019	1
				2
	00:00->01:00			3
	CT		1	4
	GROSS		·1.10	5
	NET	No	1	6
	1.90%		·1.20	7

	23:00->00:00			
	CT		1	
	GROSS		·3.45	
	NET	No	1	
	3.90%		·3.59	

	TL	CT	280	8
	GROSS		·1,937.61	9
	NET	No	25	10
			·2,096.80	11

- 1 Read symbol/report title
- 2 Report code
- 3 Time zone
- 4 No. of customers
- 5 Gross sales amount
- 6 No. of receipts
- 7 Sales ratio/net sales amount
- 8 Total No. of customers
- 9 Gross total amount
- 10 Total No. of receipt
- 11 Net total amount

Advanced programmings and registrations

■ Monthly sales report

X	MONTHLY		1
		0000020	2
1.....			3
GROSS		1236.76	4
		.12,202.57	5
NET	No	214	6
		.12,202.57	7
<hr/>			
31.....			8
GROSS		2132	9
		.14,187.57	10
NET	No	205	11
		.13,398.76	12
<hr/>			
TL			13
GROSS		9746.63	14
		.161,022.49	
		.16.52	
NET	No	2351	
		.161,022.49	
		.68.49	

- 1 Read symbol/report title
- 2 Report code
- 3 Date of month
- 4 Gross symbol/Quantity
- 5 Gross sales amount
- 6 Net symbol/No. of customers
- 7 Net sales amount
- 8 Total symbol
- 9 Gross symbol/Quantity
- 10 Gross sales amount
- 11 Daily gross sales average
- 12 Net symbol/No. of customers
- 13 Net sales amount
- 14 Daily net sales average

■ Flash report

X	FLASH		1
		0000071	2
DECLA		.6,919.04	3
		.0.00	4
GROSS		111.15	5
		.7,054.14	6
NET	No	120	7
		.7,263.20	
CAID		.6,919.04	

- 1 Read report symbol/report title
- 2 Report code
- 3 Declared amount
- 4 Difference
- 5 Gross total
- 6 Net total
- 7 Cash in drawer

About "Declared money" and "Cash in drawer"

If you programmed the register to force entry of total amount in drawer, you need to count the money in the drawer and input the amount (money declaration) before read (X) or reset (Z) report printing. On the other hand, "Cash in drawer" is the total money in the drawer calculated by the register so that you can compare the actual amount and the calculated amount.

To program money declaration, please see page E-76 "Set code 06".

■ Electronic journal

X	EJ			1
		0000058		2
REG	06-20-2018	11:58		
C01	0001	000123		
1	DEPT01	T1	.1.00	
1	DEPT02	T1	.2.00	
5	DEPT03		.5.00	3
		7 No		
TA1				
TX1			.0.15	
TX1			.0.10	
TL			- 8.10	
CASH			.10.00	
CG			.1.90	
REG	06-20-2018	11:59		
C01	0001	000124		

- 1 Report header/title
- 2 Report code
- 3 Journal image

About electronic journal

Instead of printing days' sales journal, the register stores daily sales report in the memory and you can obtain the report by assigning day or consecutive number.

Advanced programmings and registrations

To print individual department and PLUs

Instead of printing sales reports in a lump, you can obtain reports of specific departments or PLUs.

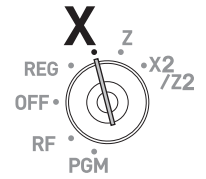

Step

- 1 Turn the Mode switch to X position.
- 2 Just press department keys or enter PLU numbers.
For example, for Dept.033.
 for PLUs 1 and 89.
- 3 Press key to exit from individual report printing.

Printout

X	INDIVIDUAL		1
DEPT028		38	2
8.13%		·257.53	3
PLU0001		17	4
0.53%		·17.00	5
#0001			6

TL		88.61	7
		·516.10	8

- 1: Read symbol/report title
- 2: Department Name/No. of items
- 3: Sales ratio/amount
- 4: PLU Name/No. of items
- 5: Sales ratio/PLU amount
- 6: PLU code
- 7: Total No. of items
- 8: Total amount

Advanced programmings and registrations

Periodic sales report

Apart from daily report, you can obtain periodic sales report. The register prints total sales data from the last periodic report. Namely, if you do this operation monthly, you can obtain monthly sales reports. The cash register allows you to obtain two kinds of periodic reports so that not only monthly reports, you can also get weekly reports.

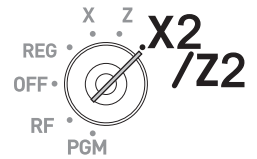

Step

1 Turn the Mode switch to X2/Z2 position. The display shows report selection screen.

Display

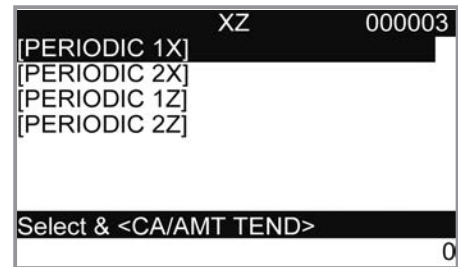

2 Select a report using or keys. 1Z and 2Z clear the accumulated data while 1X and 2X store the sales data remained.

3 Press key. The printer prints out the periodic report.

Advanced programmings and registrations

ZZ1 PERIODIC 1Z			1

ZZ1 DEPT	0001		2
	0001115		3

DEPT001	38		4
8.13%		.257.53	5
DEPT002	18		

		.1,502.26	

TL	88.61		6
		.1,916.10	7

ZZ1 FIX	0001		8
	0001111		9

GROSS	981.25		10
		.6,574.40	
NET	No 111		11
		.7,057.14	
CAID		.6,919.04	12
CHID		.139.04	13
CKID		.859.85	14
CRID(1)		.709.85	15
CRID(2)		.0.00	16
CRID(3)		.0.00	17
CRID(4)		.0.00	18

RF	No 3		19
		.10.22	
CUST	CT 111		20
AVRG		.63.57	21
DC		.1.22	22
REF		.2.42	23
ROUND		.0.00	24
CANCEL	No 2		25
		.12.97	

TA1		.2,369.69	26
TX1		.128.86	27
TA2		.2,172.96	28
TX2		.217.33	29

- 1 Report title
- 2 Department report title/reset counter
- 3 Report code
- 4 Department Name/No. of items *1
- 5 Sales ratio/amount *1
- 6 Total No. of items
- 7 Total amount
- 8 Fixed total report title/reset counter
- 9 Report code
- 10 Gross total *2
- 11 Net total *2
- 12 Cash in drawer *2
- 13 Charge in drawer *2
- 14 Check in drawer *2
- 15 Credit in drawer 1 *2
- 16 Credit in drawer 2 *2
- 17 Credit in drawer 3 *2
- 18 Credit in drawer 4 *2
- 19 Refund mode *2
- 20 Customer number *2
- 21 Average sales per customer *2
- 22 Discount total *2
- 23 Refund key *2
- 24 Rounding total *2
- 25 Cancellation *2
- 26 Taxable 1 amount *2
- 27 Tax 1 amount *2
- 28 Taxable 2 amount *2
- 29 Tax 2 amount *2

Advanced programmings and registrations

ZZ1	TRANS		0001	1
			0001112	2
CASH	No	362		3
			·1,638.04	
CHARGE	No	56		
			·1,174.85	
RC	No	4		
			·810.00	
PD			5	
			·5.00	
CORR	No	14		
			·39.55	
RCT	No	3		
NS	No	5		

ZZ1	CASHIER		0001	4
			0001117	5
C01	1		6
GROSS			513	
			·1,654.10	7
NET	No	111		
			·1,845.35	8
C02	1		9

- 1 Function key report title/reset counter
- 2 Report code
- 3 Function key count/amount *1
- 4 Clerk report title/reset counter
- 5 Report code
- 6 Clerk name
- 7 Gross total
- 8 Net total
- 9 Clerk name

- * 1 Zero totalled departments/functions (the amount and item numbers are both zero) are not printed.
- * 2 These items can be skipped by programming. See pages E-77 "Set code 08" and E-79 "Set code 09".

Advanced programmings and registrations

Bluetooth setting

This setting connects the register and a smartphone by means of Bluetooth.

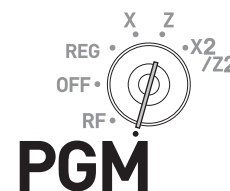

Top menu	Sub menu		What is to be set	
[Bluetooth]	System Setting	OFF	To stop sending X or Z data to a smartphone, set "X data → mobile" and "Z data → mobile" of "Function" "NO". Turns off when not using Bluetooth pairing.	
		ON	Pairing with mobile	Pairs with a smartphone.
			Clear paired mobile	Clears pairing settings.
	Functions	X data → mobile	YES	Set YES when sending X data to a smartphone.
			NO	
		Z data → mobile	YES	Set YES when sending Z data to a smartphone. Set YES with Backup if you wish to back up the data in an SD card when data transmission is performed incorrectly.
			YES with Backup	
			NO	

Setting Bluetooth pairing

The following procedures pair your cash register with your smartphone by Bluetooth connection.

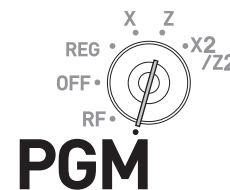

Step

1 Turn the Mode switch to PGM position and select [Bluetooth].

Display

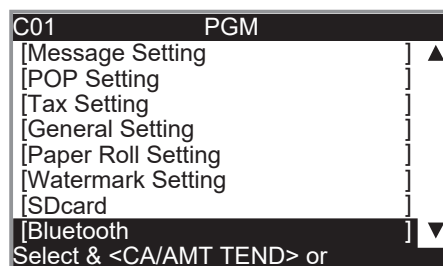



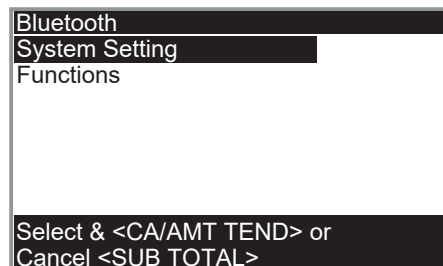

2 Press  key and select [System Setting].



Advanced programmings and registrations

Step

3 Press  key. The display shows "System Setting" [OFF]. Press  key again and select [ON] by  key.

4 Press  key and select [Pairing with mobile].

5 Press  key then activate Bluetooth on your smartphone. On the smartphone, find and select the device code of the cash register shown on the display. In this example, 12345678901234.

Note that the device code differs depending on each cash register. Make sure to select the same code shown on the cash register display.

6 After you select the device code on the smartphone, the cash register then shows a pass key on the display. Enter the pass key (in this example, 123456) on the smartphone. Pass key differs depending on each cash register.

7 Now your cash register and your smartphone are paired by Bluetooth connection.

Display

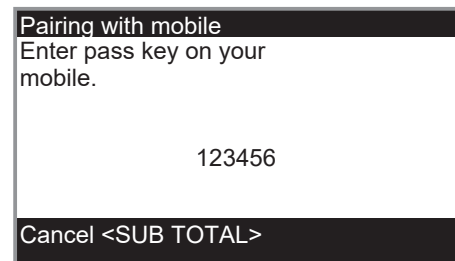
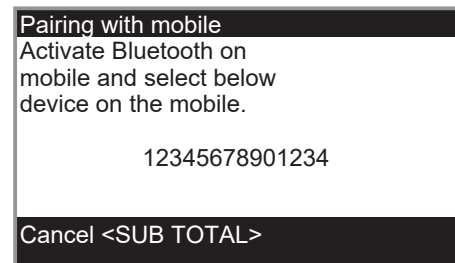
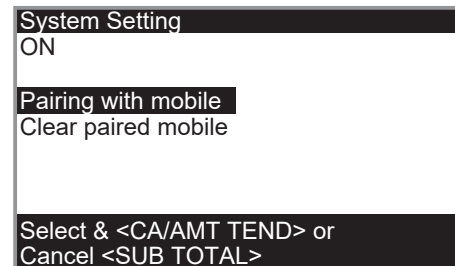
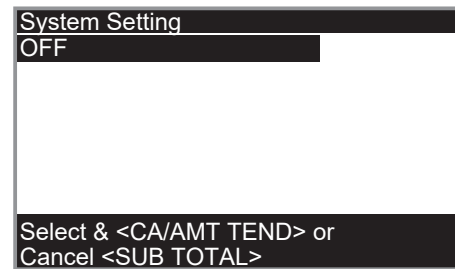

You can perform detail settings or data exchange using Bluetooth connection.
Please refer to the website <http://web.casio.com/ecr/app/>.



Using an SD card

Cautions when using optional SD memory card

This cash register accepts only SD or SDHC memory cards.

- The cash register supports SD cards conforming to SD standard. Capacity of the cards must be less than 2GB for SD card, between 2GB and 32GB for SDHC card.
- * Please note that we do not guarantee for all the performances and data-handling capacities of SD or SDHC memory cards even the above conditions are satisfied. We recommend that you use new SD card.
- Please do not extract the SD card or turn the power of the cash register off while the register is accessing to the card. It may cause to damage data.
- Recorded data may be damaged or lost by electric noise or static electricity. We recommend that you back up important data.

You can store sales data or program data to an SD card or you can restore the data from SD card to your cash register.

The following table explains what you can do with an SD card.

Backup→SD	Stores sales data and program data of register to SD card.
Restore←SD	Restores sales data and program data from SD card to register.
Program→SD	Stores program data to SD card.
Program←SD	Restores program data from SD card to register.
SD Format	Formats an SD for the first usage.
Backup→Flash	Stores program data into the register's built-in flash memory (for a case of power failure with flat batteries).

The following sections explain the operation examples of the features using an SD card.

Advanced programmings and registrations

To format an SD card

When you use unformatted new SD card, you must format the SD card first.

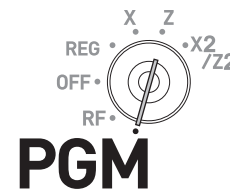

NOTE All the data stored in the SD card will be cleared if you execute formatting. It may take time to access to an SD card immediately after it is formatted.

Step

Display

- 1 Insert an SD card into the SD card slot.
- 2 Turn the Mode switch to PGM position and select [SD card].
- 3 Press key.
Select [SD Format] on the SD card setting screen.
- 4 Select [YES] and press key.
The register starts to format the SD card.
- 5 Now the SD card is formatted and you can use it for storing cash register data in it.

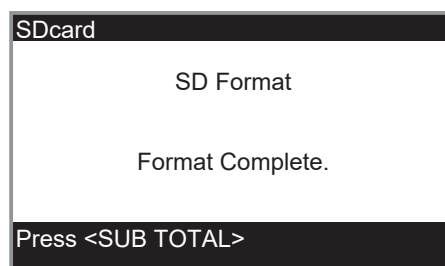
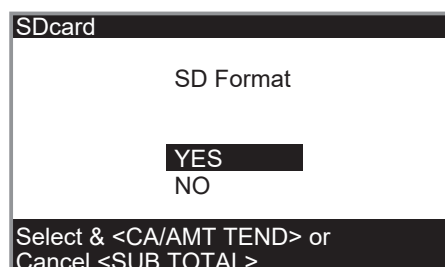
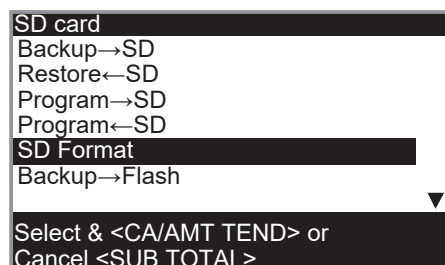
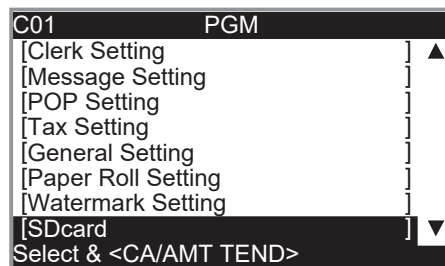
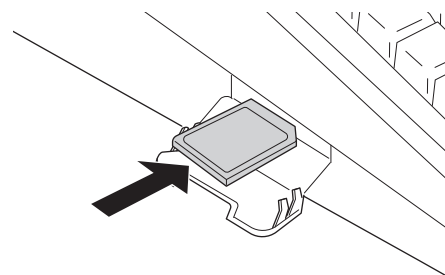

Advanced programmings and registrations

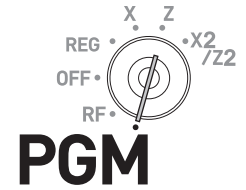

To store program data in an SD card

The following operation explains how you can back up all the program data in an SD card.



Step

Display

- 1 Insert an SD card into the SD card slot.
- 2 Turn the Mode switch to PGM position and select [SD card]. Then press  key.
- 3 Select [Program→SD] and press  key.
- 4 Select [YES] and press  key.
- 5 After for a while, the display indicates “Backup complete”.

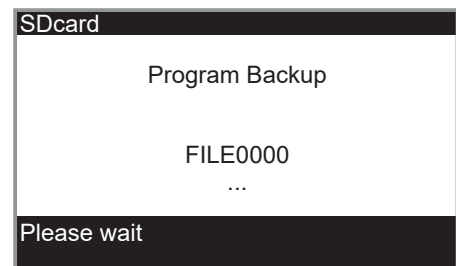
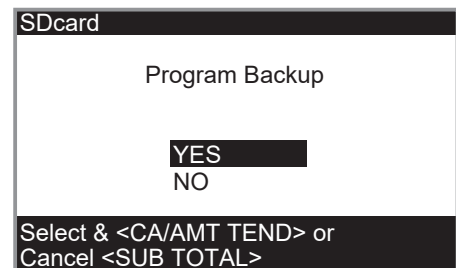
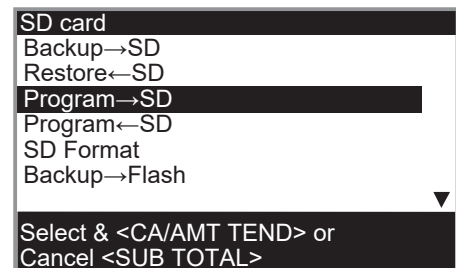
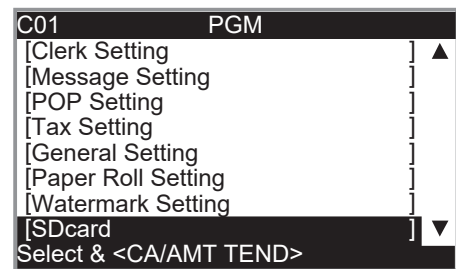

Advanced programmings and registrations

Restoring backup data (automatically backed up setting data) from built in flash memory

Other than in an SD card, setting data (except sales data) may be backed up in the built in flash memory as well as in an SD card (printer prints "Data Backup Normal End"). If AC power cord is plugged out while battery power is low, all the setting data will be cleared and the cash register needs to be initialized. In such a case, setting data can be restored if the data is in built in flash memory. Please follow the instructions on the display for reading setting data or initializing the data.

POP setting

According to the setting conditions, several POP images can be selected and printed on the lower part of receipts.

Top menu	Sub menu			What is to be set
[POP Setting]	Read POP Data			Reads POP data from an SD card.
	POP Operation Setting	POP Printing Conditions	Always print Same POP	Always prints the same POP image.
			Change POP By Amount	By the amount, POP image can be changed according to the "Setting (by Amount)" setting
			Change POP By Item	Prints POP image according to the set POP No. of DEPT Setting.
			Do Not Print	No POP image is printed.
		Setting (Always same)		Selects a POP image from five images.
		Setting (by Amount)	Amount 1	Sets condition to print POP message in accordance with the amount. Three kinds of POP images can be set in accordance with the amount. The amount is set by $A \times 10^B$. Example • 12.00 A=12,B=2 • 100.00 A=1,B=4
			Amount 2	
	Amount 3			
	Print POP image			Prints set POP image to check.

NOTE

- POP images read by [Read POP Data] must be stored in an SD card beforehand using "ECR Setting tool" of an PC.
- POP images printed by "Setting (by Amount)" are; Amount 1 = image 1, Amount 2 = image 2, and Amount 3 = image 3.
- When several conditions of "Settings (by Amount)" are satisfied, the priority order is Amount 3 > Amount 2 > Amount 1.

Handling of the cash drawer

To lock and unlock the cash drawer

Turning the drawer key clockwise locks the drawer and turning counterclockwise unlocks the drawer.

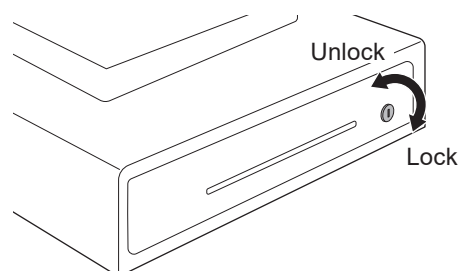

To pull out the cash drawer

1 Remove the bill coin tray.

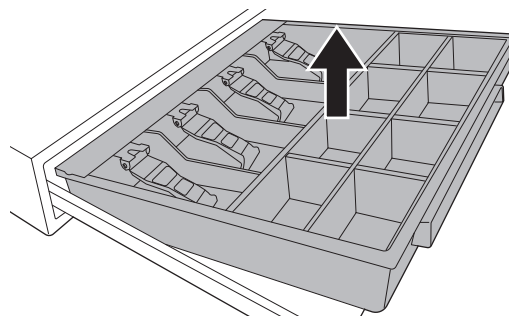

2 Lifting the front part of the drawer, pull it out.

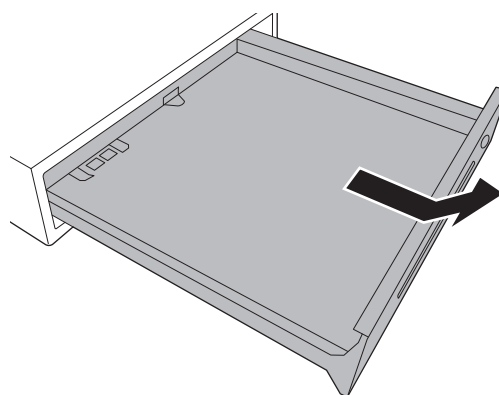

Advanced programmings and registrations

To remove coin divider (certain models)

For the models with a hook on lower part of coin divider, you can move the coin partition.

1 Pushing down the hook, lift up the coin partition.

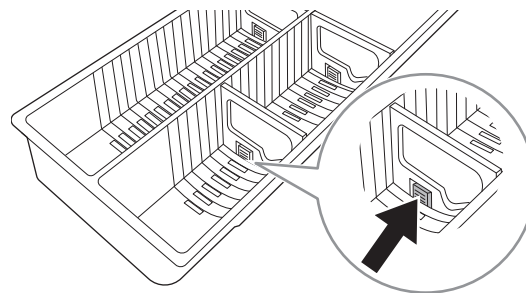

2 To set the partition, insert it in the groove on the coin case and push it until it is hooked. You can check the state of the hook from the bottom of the coin case.

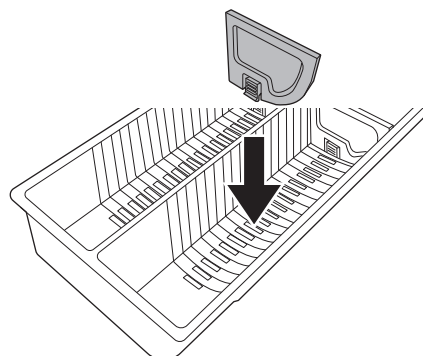

NOTE

- Some types of cash drawers cannot remove the coin partition.
- The shape of coin case differs depending on the number of coin partitions.

Advanced programmings and registrations

Before you consider it as a problem

Error code table

Error code	Message	Meaning	Action
E001	Wrong mode	Mode switch position changed before finalization.	Return the mode switch to its original setting and finalize the operation.
E003	Wrong operator	The signed on clerk differs from the clerk performed the tracking check registration.	Input correct check number or assign the proper clerk number.
E004	Error INIT/FC	Initialization or unit lock clear operation in progress.	Complete operation.
E008	Please sign on	Registration without entering a clerk number.	Enter a clerk number.
E010	Close the drawer	The drawer is left open longer than the program time (drawer open alarm).	Close the drawer.
E011	Close the drawer	Attempt to register while the cash drawer is open.	Close the drawer.
E016	Change back to REG mode	Two consecutive transactions attempted in the refund mode.	Switch to another mode and then back to the RF mode for the next transaction.
E017	Enter CHK/TBL number	Attempt made to register an item without inputting a check number.	Input a check number.
E018	Enter Table number	Attempt made to register an item without inputting a table number.	Input a table number.
E019	Enter number of customers	Finalize operation attempted without entering the number of customer.	Enter the number of customer.
E021	No DEPT Link	No department linked PLU is registered.	Correct the program.
E026	Enter condiment/preparation PLU	No condiment/preparation PLU is registered.	Register condiment/preparation PLU.
E029	In the tender operation	Item registration is prohibited, while partial tender.	Finalize the transaction.
E031	Press ST key	Finalization of a transaction attempted without confirming the subtotal.	Press  key.
E033	Enter tendered amount	Finalize operation attempted without entering amount tender.	Enter the amount tendered.
E035	Change amount exceeds limit	Change amount exceeds preset limit.	Input amount tendered again.
E036	Remove money from the drawer	Contents of the drawer exceed programmed limit.	Perform payout operation.
E037	Digit or amount limitation over	High amount lock out/low digit lock out error	Enter correct amount.
E038	Perform money declaration	Read/reset operation without declaring cash in drawer.	Perform money declaration.

Advanced programmings and registrations

Error code	Message	Meaning	Action
E040	Issue guest receipt	Attempt to register a new transaction without issuing a guest receipt.	Issue a guest receipt.
E046	REG buffer full	Registration buffer full.	Finalize the transaction.
E049	CHECK memory full	Check tracking index memory full.	Finalize and close the check number currently used.
E050	DETAIL memory full	Check tracking detail memory full.	Finalize and close the check number currently used.
E051	CHK/TBL No. is occupied	Attempt to made use <New Check> to open a new check using a number that is already used for an existing check in check tracking memory.	Finalize and close the check that is currently under the number that you want to use or use a different check number.
E053	CHK/TBL No. is not opened	Attempt made to use <Old Check> reopen a new check using a number that is not used for an existing check in check tracking memory.	Use the correct check number (if you want to reopen a check that already exists in check tracking memory) or use <New Check> to open a new check.
E075	Negative balance cannot be finalized	Attempt to finalize a transaction when balance is less than or equal to zero.	Register item(s) until the balance becomes positive amount.
E101	PLU maintenance file full. Press <#2> to exit	PLU direct maintenance/batch maintenance file becomes full.	Terminate the maintenance.
E103	PLU Code is not exist. Input the PLU Code	PLU code is not existed in the file.	Enter proper PLU code.
E105	PLU file full	PLU file full	Modify the designated item.
E106	Item exists in the PLU FILE	The designated item has already existed in the PLU file.	
E112	Close the journal platen arm	The journal platen arm is opened.	Close the journal platen arm.
E114	Close the receipt platen arm	The receipt platen arm is opened.	Close the receipt platen arm.
E139	Negative balance is not allowed	Attempt to register <--> or <CPN> when the balance becomes negative.	Enter proper minus/coupon amount.
E146	Arrangement file full	Arrangement file is full.	Set the arrangement properly.
E164	Employee No. is not Found in the Employee File	Attempt to enter a wrong employee number which is not set to the employee file.	Enter proper employee number.
E200	Insert SD	SD is not inserted.	Set SD.
E201	Illegal Format	Illegally formatted SD	Format the SD.
E202	File not found	The designated file is not found in the SD.	Enter proper file name.

Advanced programmings and registrations



Error code	Message	Meaning	Action
E204	Check the write protect switch	Write protect switch of the SD card is on.	Turn the write protect switch off.
E205	File already exist.	Cannot write, because designated file has already been in the SD.	Check the operation and retry.
E220	(Bluetooth error) No device is connected via Bluetooth.	No device is connected via Bluetooth.	Activate Bluetooth on your mobile and connect with the cash register.
E221	(Bluetooth error) Bluetooth communication error.	Bluetooth communication error.	Your mobile may be out of range. Please place your mobile closer to the cash register. If possible, move away microwaves, wireless routers or other Bluetooth devices from this cash register.

Advanced programmings and registrations

About HELP guidance

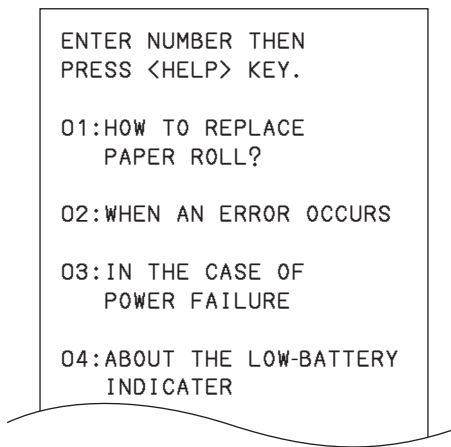
In any Mode switch position, pressing  key prints a guide menu shown below.



Enter the guidance number and press  key. The printer prints the guidance what to be done. For example, enter **0 4** and press  key to print the guidance in case LOW-BATTERY is shown on the display.

When “EJ FULL” sign appears on the display

When the register shows this sign, issue electronic journal read report (if necessary) and reset the memory immediately.

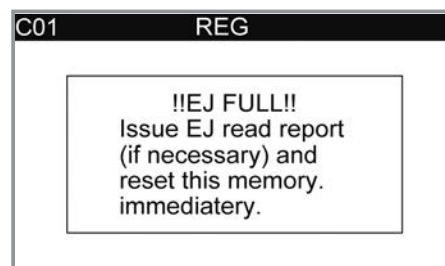



In case of power failure

If the power supply to the cash register is cut by a power failure or any other reason, simply wait for power to be restored. The details of any ongoing transaction as well as all sales data in memory are protected by the memory backup batteries. (This is the reason to install the batteries.)

- Power failure during a registration
The subtotal for items registered up to the power failure is retained in memory. You will be able to continue with the registration when power is restored.
- Power failure during printing a read / reset report
The data already printed before the power failure is retained in memory. You will be able to issue a report when power is restored.
- Power failure during printing of a receipt / journal
Printing will resume after power is restored. A line that was being printed when the power failure occurred is printed in full.
- Other
The power failure symbol is printed and any item that was being printed when the power failure occurred is reprinted in full.

In case the register is locked up

If you make a mistake in operation, the cash register may lock up to avoid damage to programs and preset data. Should it happens, you can use the following procedure to clear the lock up without losing any data.

- 1 Insert the PGM key in the mode switch.
- 2 Turn the mode switch to OFF mode.
- 3 Press down , and turn the mode switch to PGM mode.
- 4 The display shows “FFFFFFFFF”, then release .
- 5 Press,  then issue a receipt.

Advanced programmings and registrations

About the low battery indicator

If this indicator appears when you switch the cash register on, it can mean one of three things:

- No memory backup batteries are loaded in the cash register.
- The power of the batteries loaded in the unit is below a certain level.
- The batteries loaded in the unit are dead.

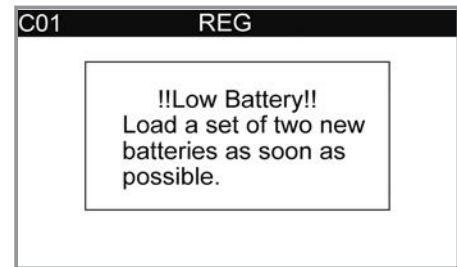

Important !

Whenever the low battery indicator appears on the display, load a set of two new batteries as soon as possible. If there is a power failure or you unplug the cash register when this indicator appears, you will lose all of your sales data and settings.

Be sure to keep the power cord of the cash register plugged in whenever you replace the batteries.

Category	No. of totalizers	Contents				Periodic totalizer
		Amount (10 digits)	No. of items (4 digits)	Count (4 digit)	No. of items (4 digits)	
Department	200	○ *1	○ *3			○
PLU	7000	○ *1	○ *3			
Hourly sales	24	○ *1		○ *4	○ *5	
Monthly sales	31	○ *1			○ *5	
Clerk	50	○ *1			○ *5	
Transaction key & fix total	--	○ *1 or ○ *3 or ○ *4 or ○ *5				○
Non resettable grand sales total	1	○ *2				
Reset counter	8			○ *4		○
Consecutive No.	1				○ *5	

* 1 -9,999,999.99 ~ 99,999,999.99

* 2 -9,999,999,999,999.99 ~ 99,999,999,999,999.99

* 3 -99,999.999 ~ 999,999.999

* 4 1 ~ 9999

* 5 1 ~ 999999

Specifications and design are subject to change without notice.

About open source code

The software of our product includes the work that is distributed in the Apache License 2.0. You may obtain a copy of the License at "<http://www.apache.org/licenses/LICENSE-2.0>".

Advanced programmings and registrations

Specifications

Entry	10-key system, buffer memory 8 keys (2-key roll over)	
Department	Full key system	
Main display	26 characters x 10 lines, Dept. name, PLU name, Total, Transaction names, Change	
Customer display	20 characters x 1 line. Amount 10 digits (zero suppression)	
Printer		
Receipt	Thermal alpha-numeric system 24 digits, receipt on/off key Store name or slogan is printed automatically	
Journal	Thermal alpha-numeric system 24 digits Automatic take up roll winding	
Paper roll	58 (W) × 80 (D) mm Φ(Max.)	
Paper thickness	0.06 to 0.08 mm	
Paper feed	Receipt and Journal	
Print speed	About 20 l/s	
Listing capacity		
Amount	9999999999	
Quantity	9999.999	
Tendered amount	9999999999	
Percent	99.99	
Tax rate	9999.9999	
Numbers	9999999999999999	
Chronological data		
Date print	Automatic date printout on receipt and journal, automatic calendar	
Time print	Automatic time printout on receipt and journal, 24-hour system/12-hour system	
Alarm	Key catch tone, error alarm	
Memory protection battery	The effective service life of memory protection batteries (two new size AA alkaline batteries) is approximately one year from installation into the machine.	
Power supply/power consumption	See the rating plate.	
Operation temperature	0°C to 40°C (32°F to 104°F)	
Humidity	10 to 90% RH	
Dimensions	220 mm (H) × 400 mm (W) × 450 mm (D) (8.6" (H) × 15.7" (W) × 17.7" (D))	
Weight	9 kg (20 lbs.).	
Data communication specifications		
Bluetooth	Supported version	Bluetooth® low energy (Ver. 4.1 +LE)
	Communication range	Approximately 3 m (10ft) (depends on radio wave conditions and environment)
External interface	SD/SDHC memory card slot x 1 COM port x 2	
Option	WT-94	
Accessories	Roll paper, Mode keys, Drawer keys, Magnetic plate*, Manuals *Use this plate for tacking the notes received from customer.	

CASIO®



ENGLISH

Disposal of Waste Electrical & Electronic Equipment of products for Household use

The symbol (crossed out wheeled-bin) on your product indicates that the product shall not be mixed or disposed with your household waste, at their end of use.

This product shall be handed over to your local community waste collection point for the recycling of the product.

For more information, please contact your Government Waste-Disposal department in your country.

Inappropriate waste handling could possibly have a negative effect on the environment and human health due to potential hazardous substances. With your cooperation in the correct disposal of this product, you contribute to reuse, recycle and recover the product, and our environment will be protected.

Disposal of Waste Electrical & Electronic Equipment of products for business use

For further information regarding the disposal of products for business purposes, please contact your dealer or distributor in your country. This product shall not be mixed or disposed with commercial waste.

Deutsch

Entsorgung von elektrischen & elektronischen Produkten für den Haushaltsgebrauch

Dieses Symbol (ausgekreuzte Mülltonne) auf dem Produkt bezeichnet, dass Allgeräte usw. nicht wie normaler Haushaltsabfall in den Müll gegeben werden dürfen, sondern zum Recycling an einer hierfür vorgesehenen Annahmestelle abzugeben ist.

Für nähere Informationen wenden Sie sich bitte an die für Müllentsorgung zuständigen örtlichen Behörden.

Bei unsachgemäßer Entsorgung besteht das Risiko nachteiliger Auswirkungen auf Umwelt und Gesundheit durch potentiell gefährliche Substanzen. Durch Ihre Kooperation zur ordnungsgemäßen Entsorgung fördern Sie die Wiederverwendung, das Recycling und die Rückgewinnung von Stoffen und tragen zum Umweltschutz bei.

Entsorgung von elektrischen & elektronischen Produkten durch gewerbliche Benutzer

Für nähere Informationen zur Entsorgung durch gewerbliche Benutzer wenden Sie sich bitte an Ihren Händler oder den zuständigen Vertrieb. Das Produkt darf nicht in den normalen Gewerbehüll gegeben werden.

Français

Traitement des appareils électriques et électroniques en fin de vie par les particuliers

Ce symbole (poubelle interdite) apposé sur le produit indique qu'en fin de vie ce produit ne doit pas être traité avec les déchets ménagers. Il doit être remis à un point de collecte approprié pour le recyclage des appareils électriques et électroniques.

Pour de plus amples informations, veuillez contacter le service de collecte des déchets ménagers local.

Un traitement inadéquat des déchets contenant des substances potentiellement dangereuses peut avoir des effets néfastes sur l'environnement et la santé humaine.

Traitement des appareils électriques et électroniques en fin de vie par les entreprises

Pour de plus amples informations sur la collecte des déchets des professionnels, veuillez contacter votre revendeur ou distributeur local. Ce produit ne doit pas être traité avec les déchets d'entreprises.

Italiano

Smaltimento di rifiuti costituiti da prodotti elettrici e elettronici per uso domestico

Il simbolo (un bidone con ruote sbarrato da una croce) sul prodotto indica che il prodotto non deve essere miscelato o smaltito con i rifiuti domestici, alla fine della sua durata.

Questo prodotto deve essere consegnato al punto di raccolta rifiuti della propria Comunità locale per il suo riciclaggio.

Per ulteriori informazioni, rivolgersi all'organo statale preposto allo smaltimento dei rifiuti nel proprio paese.

Uno smaltimento dei rifiuti inappropriato può avere effetti negativi sull'ambiente e sulla salute umana a causa di sostanze potenzialmente pericolose. Collaborando allo smaltimento corretto di questo prodotto, si contribuisce al riutilizzo, al riciclaggio e al recupero del prodotto, e alla protezione del nostro ambiente.

Smaltimento di rifiuti costituiti da prodotti elettrici e elettronici per uso commerciale

Per ulteriori informazioni riguardanti lo smaltimento di prodotti per uso commerciale, rivolgersi al proprio rivenditore o distributore nel proprio paese. Questo prodotto non deve essere mescolato o smaltito con i rifiuti commerciali.

Español

Disposición sobre Residuos de aparatos eléctricos y electrónicos para los productos de uso doméstico

Los productos identificados con este símbolo (papelera tachada) no deben eliminarse como residuos domésticos una vez finalizada su vida útil.

Este producto debe entregarse a un punto de recogida de la comunidad local para su recuperación y reciclado.

Para mayor información, sírvase ponerse en contacto con el Departamento de Disposición de Residuos de su Ayuntamiento.

El manejo inadecuado de los residuos supone riesgos para la salud humana o el medio ambiente. Con la reutilización, el reciclado de los materiales u otras formas de valorización de tales productos usted contribuye de manera importante a la protección de nuestro medio ambiente.

Disposición de residuos de aparatos eléctricos y electrónicos para los productos de uso profesional.

Para más información sobre la disposición de productos con fines profesionales, sírvase ponerse en contacto con el vendedor o distribuidor oficial de su país. Este producto no debe mezclarse ni desecharse junto con otros residuos.

Nederlands

Afvalverwijdering van Elektrische & Elektronische Apparatuur voor Huishoudelijk Gebruik

Het symbool (doorgesleutel afvalbak op wielen) op het product geeft aan dat het product aan het einde van haar levensduur niet samen met of in de vorm van huishoudafval mag worden weggegooid.

Het product moet naar een verzamelplaats (milieudepot) worden gebracht waar dergelijke producten worden gerecycled.

Neem voor meer informatie contact op met de relevante overheidsafdeling voor afval/milieu die in uw land bestaat.

Het kan nadelige gevolgen hebben op voor mens en milieu als afval op een verkeerde manier wordt behandeld waardoor potentieel schadelijke stoffen vrij komen. Door uw medewerking te verlenen en dit product op de juiste wijze wegwerpt, kunt u een bijdrage leveren aan het herstellen, hergebruiken en recycelen van dit product om zo ons milieu te beschermen.

Afvalverwijdering van Elektrische & Elektronische Apparatuur voor Zakelijk Gebruik

Voor nadere informatie aangaande het wegwerpen van producten voor zakelijk doeleinden, wordt u verzocht contact op te nemen met uw dealer of de distributeur in uw land. Dit product mag niet worden met of in de vorm van commercieel afval worden weggegooid.

Svenska

Bortskaffning av förbrukade elektriska & elektroniska produkter för hushållsbruk

Denna symbol (en överkorsad sopkorg) på produkten innebär att produkten ej ska blandas eller slängas med ditt hushållsavfall när den är förbrukad.

Produkten ska lämnas för återvinning till en lokal samlingsplats för denna slags produkter.

Kontakta kommunkontoret för närmare detaljer om var du finner sådana samlingsplatser.

Öppning av fallisshattning kan få negativa effekter på miljön och på mänsklig hälsa då en produkt kan innehålla farliga ämnen. Vi ber om ditt samarbete i bortskaffningen av denna produkt för att bidra till återvinning, återanvändning och en hälsosammare miljö.

Bortskaffning av förbrukade elektriska & elektroniska produkter för affärsbruk

Kontakta din handlare eller distributor för närmare detaljer om bortskaffning av produkter som använts i affärsyfte. Denna produkt får inte blandas eller slängas med annat affärsavfall.

Dansk

Bortskaffelse af udtjent elektrisk og elektronisk udstyr i produkter til hjemmebrug

Symbolet (en overstreget affaldsspand med hjul) på produktet angiver, at produktet ikke må blandes med eller bortskaffes sammen med almindeligt husholdningsaffald, når det er udtjent.

Produktet skal afleveres til det lokale affaldsindsamlingssted til genbrug.

Kontakt venligst afdelingen for bortskaffelse af affald i din kommune angående yderligere information.

U hensigtsmæssig bortskaffelse af affald kan have en negativ virkning på miljøet og folks helbred, da det kan indeholde potentielt farlige substanser. Med din medvirken i henseende til skriftsmæssig bortskaffelse af dette produkt, kan du bidrage til at genbruge, recirkulere og genvinde produkterne og samtidigt medvirke til, at vores miljø vil blive beskyttet.

Bortskaffelse af udtjent elektrisk og elektronisk udstyr i produkter til forretningsbrug

Kontakt venligst din forhandler eller distributor der, hvor du bor, angående yderligere information om bortskaffelse af produkter til forretningsbrug. Dette produkt må ikke blandes med eller bortskaffes sammen med kommercielt affald.

