

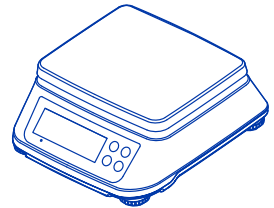

RETAIL WEIGHING SOLUTION™

Simple weighing scale
OWNER'S MANUAL

SW II
SERIES



CAS

CONTENTS

PRECAUTIONS	4
PREFACE	6
NAMES AND FUNCTIONS	6
OPERATIONS	8
1. Simple Weighing Mode	8
2. Weighing with Tare	8
3. Changing Unit of Weight	9
4. Hold Function	9
5. Comparator Function	10
6. Counting Function	11
7. Setup Mode	13
8. Interface in Detail	15
BATTERY MAINTENACE	17
ERROR MESSAGE	17
SPECIFICATIONS	18

PRECAUTIONS



Warning

Precautions when installing the scale. To ensure that you get the most from your scale, please follow these instruction.



Do not disassemble the scale.

When any damage or defect occurs, contact your CAS authorized dealer immediately for proper repair.

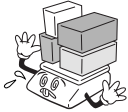

Do not overload beyond the maximum weight limit.



Scale must be grounded to minimize electricity static.

This will minimize defect or electric shock.



Do not pull the plug by its cord when unplugging.

Damaged cord could cause electric shock or fire.



To prevent from fire occurring, Do not place or use the scale near flammable or corrosive gas.



To reduce electric shock or incorrect reading, Do not spill water on the scale or place it in humid condition.



Avoid placing the scale near heater or in direct sunlight.

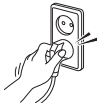

Insert plug firmly to wall outlet to prevent electric shock.



Use proper Adapter.

Incorrect adapter could damage the scale.

PRECAUTIONS



Attention

Make sure to plug your scale into the proper power outlet.

For maximum performance, plug into a power outlet 30 minutes before the usage for warm up.



For consistent and accurate reading, maintain periodical check by your CAS authorized dealer.



Avoid sudden shock to the scale.



Grab on the bottom of the scale when moving.



Keep the scale away from other electromagnetic generating devices.

This may interfere with accurate reading.



Place the scale on firm and temperature consistent environment.



By adjusting 4 corners of the scale, set the scale even using the built in scale leveling indicator.



Take the battery out when scale is not in use for long time. Leakage from the batteries is hazardous.

PREFACE

Thank you for purchasing CAS SWII series.

These series have been designed with CAS reliability, under rigid quality control and with outstanding performance. Your special departments can enjoy these high quality reliable CAS products.

We believe that your needs will be satisfied and you will have proper reliability.

This manual will help you with proper operation and care of the SWII.

Please keep it handy for future reference.

NAMES AND FUNCTIONS



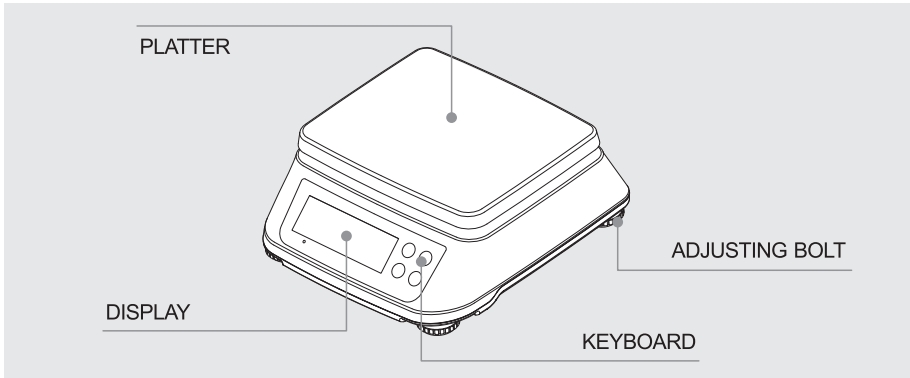



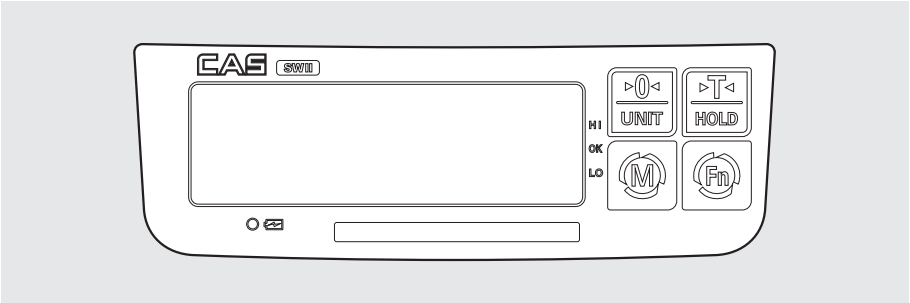

OVERALL VIEW



DISPLAY &



KEY FUNCTIONS

KEYS	FUNCTIONS
	Used to set the zero point.
	Used to input or cancel the weight of tare.
	Used to change the unit of weight, and shown as following sequence on the display. [kg] → [WL on or off] → [PCS] → [kg]
	Used to select and hold or unit conversion function
 + 	Used to convert the unit of weight.
 + 	Used to make the weight of commodity stable. This weight is average value.

OPERATIONS

- Turn on the ON/OFF switch. Then, the display will show all the segments and count up "9" to "0".
- When the weight becomes stable the display shows the stable sign (O) on.
- You may need to make it "0.000" by pressing  key unless the display indicate "0.000" under the empty platter.

1. Simple Weighing Mode

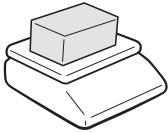

① Place a commodity on the platter.

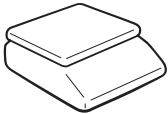

② Remove the commodity from the platter.

2. Weighing with Tare

- TARE means the weight of container being used for a commodity.
- TARE key function is to subtract the weight of the container from full weight loaded.

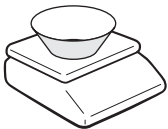

① Place a container on the platter.



② Press the  key.

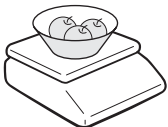

③ Place a commodity into the container, then the display will show only the weight of the commodity.

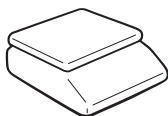



④ Remove container and commodity, then the display will show the weight of the container with "-" symbol.



⑤ Press the  key, then display will show the "0.000".

3. Changing Unit of Weight

- Press the  and  key
You may select kg, lb, or oz as the unit of weight.

4. Hold Function



① When the weight is unstable, press the  key



② "-Fn-" will be displayed



③ Press the  key. Then "hOLD" will be displayed twice



④ Then average value will be show twice And the " hOLD " function will be removed automatically

5. Comparator Function - HI / LOW Limit Setting



① Press the  key until the display shows "WL OFF". "WL OFF" means that comparator function is not activated.





② Press  key to activate this function. The display shows "WL ON".





③ Press  key once to set up the low limit. The display shows "1.000" and the first number flashes.



④ Press the  key to have number increase. To move flash to next digit, press the  key.



⑤ Press  key to set up HIGH limit. The display shows "2.000" and you can change these numbers by pressing  key. If you want to move to next digit you can go by pressing  key.



⑥ If you set up HIGH limit you can go out by pressing  key, and "End" message on the display.

⑦ If you set up HIGH limit and LOW limit incorrectly, "Err" will be shown on the display. Then you may need to set it up again. For example, setting LOW LIMIT=2.990 kg and HIGH LIMIT=1.990 kg this is incorrect setting because HIGH limit is lower than the LOW limit. When HIGH and LOW limit are set as the same or above maximum capacity it still shows "Err" message.

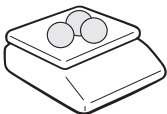

⑧ Suppose that the HIGH limit and LOW limit are set up as 2.990kg and 1,990kg respectively. If the weight loaded is 2kg between HIGH and LOW limit the display shows "OK" and the

scale continues to beep slowly.
If the weight loaded is above 2.990kg, HIGH
limit, the scale continues to beep rapidly.

6. Counting Function

• Counting without Tare

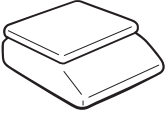

① Initial display as above.



② Press  key twice to go to sample unit selection mode



③ Press  key to select the number of sample unit. You can select 10, 20, 50, 100, 200, or 500 as a sample unit.

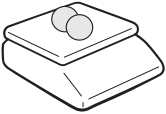

④ If you select "P = 10" as a sample unit, then please put 10 sample units on the scale.

Then press  key to set sample units.

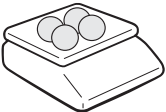

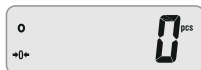
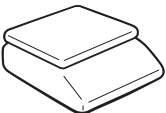

⑤ Put all of commodities you wish to count, and then check the number of pieces on display.



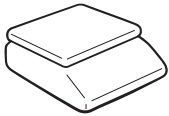

⑥ Remove all of commodities from the scale.

● Counting with Tare

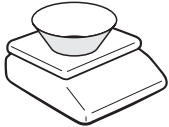

① Press  key twice to go to sample unit selection mode. "P = 0" is shown on the display,



② Put the container on the scale and press  key to set weight of tare. You can select 10, 20, 50, 100, 200, or 500 as a sample unit, by pressing  key.

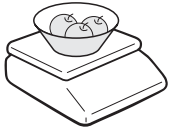

③ If the number of selected sample unit is 20, please put 20 sample units on the scale. Then press  key to set unit weight.

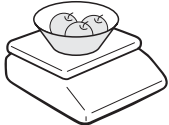

④ Put all of commodities you wish to count, and then count the number on display.

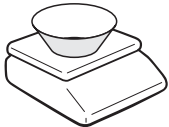

⑤ Remove all of commodities from the scale.

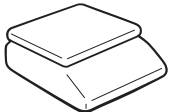

⑥ Remove the tare from the platter.

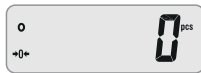
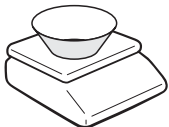

⑦ Press "Tare" key to exit from tare function.

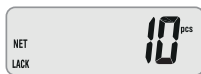
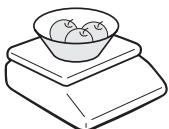

⑧ When you try to set the number of sample unit at the ③ stage, the display may show "LACK" message shortly. The result of counting may be incorrect in the following cases.

- a. unit weight $\leq 1/2 e^*$
- b. weight loaded $\leq 2\%$ of maximum weighing capacity.

* "e" value may be various on capacity of product model.

Please refer to "SPECIFICATION" on page 15. For example, a product model which capacity is 3.000 kg has 1g as "e" value

7. Setup Mode

This function is helpful to setup user setting, which is about Backlight and communication. The following is the setting procedure of Backlight On/Off & RS-232C communication.



① Make sure that power is OFF.

While pressing the key, turn on the scale. The display shows "U – SEt" (When you release the key, it will show you the current settings)



② You can change by pressing the key. Please refer to "TABLE 1".



③ Press the key to save the setting. Then, the display will show "RS-St" and turn to RS-232C setting (Default setting is "RS-St").

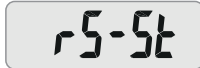

④ You can change by pressing the key. Please refer to "TABLE 1".



⑤ Press the key to save the setting. Then, the display will show all the segments and count up "9" to "0".

TABLE 1.

MENU	DISPLAY	DESCRIPTION
Backlight		Do not use a back-light
		Use back-light when you put on the weight
		Use back-light always
RS-232C		If weight is stable, transmit the data.
		If weight is stable and after adding the weight, transmit the data after press button 'zero' key.
		Transmit the data continually.
		Communicate with PC

8. Interface in Detail

This function is helpful to understand RS-232C Communication user setting. The following is the communication information of RS-232C.

● RS-232C Port Connection

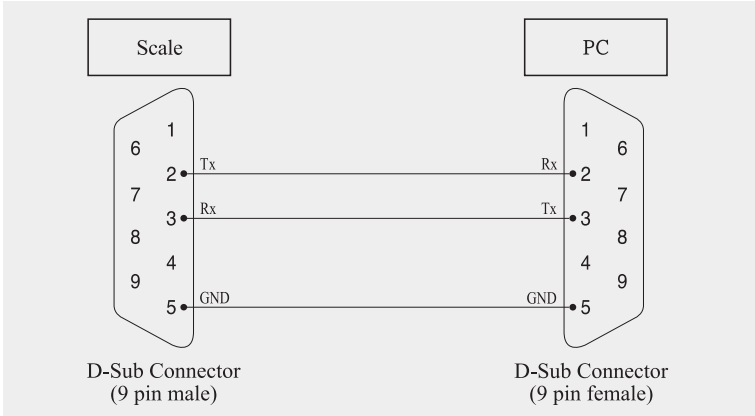

- ➔ 8-BIT ASCII code
- ➔ None parity
- ➔ 1 stop bit
- ➔ baud rate 9600

● USB INTERFACE(Device)

USB Type B Socket

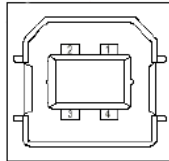

- 1=Vbus (5V)
- 2=D-
- 3=D+
- 4=GND

● RS-232C Protocol

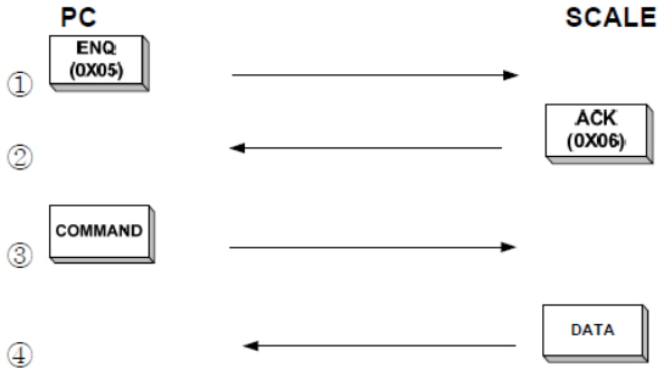

Transmission Data description

DATA	Value(HEX)	Description
SOH	01h	Start of heading
STX	02h	Start of text
STA	S(53h),U(55h)	S: Stable , U:Unstable
SIGN	-(2Dh),SP(20h)	Sign of the weight data
W5~W0		Weight data
UN1,UN2	KG,LB	Unit of Weight
BCC		Block check character exclusive or(^)
ETX	03h	End of text
EOT	04h	End of transmission

COMMAND : DC1(0x11) SCALE->PC DATA FORMAT

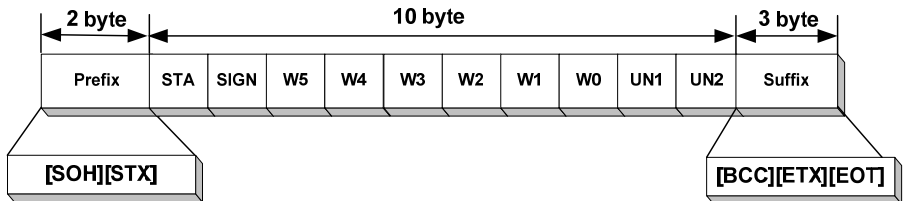

BATTERY MAINTENANCE

LOW BATTERY WARNING

This product is a combination product dry battery and rechargeable battery. When the battery is low the display shows the "LowbAt" sign.





You can replace the battery new one.

If rechargeable battery, please charge immediately.

You can shorten battery life.

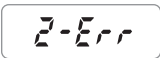
If you still use the scale without replacing the battery the scale may provide incorrect result on measurement.

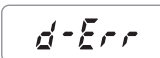
ERROR MESSAGE

Error Message on Display	Description	Solution
	The "Z-Err" occurs when a current zero point has shifted from the last span calibration.	Please call your CAS dealer.
	When HIGH and LOW limit are set as the same or above maximum capacity it still shows "Err" message.	Please reset the maximum and minimum capacity.
	The "d-Err" message will be shown when HIGH and LOW limits of comparison functions are set as inadequate unit value	Please reset the unit value setting again to be adequate.
	The "Err 3" is an overload error.	Please remove the weight
	The " LowbAt " is battery low.	Please change new battery. If rechargeable battery, please charge immediately.

SPECIFICATIONS

MODEL : SWII

Capacity	Dual Interval	Single	Dual Interval	Single	Dual Interval	Single	Dual Interval	Single
	Max 1.5/3kg	Max 3kg	Max 3/6kg	Max 6kg	Max 6/15kg	Max 15kg	Max 15/30kg	Max 30kg
e	e=0.5/1g	e=1g e=0.5g e=0.2g e=0.1g	e=1/2g	e=2g e=1g e=0.5g e=0.2g	e=2/5g	e=5g e=2g e=1g e=0.5g	e=0.5/1g	e=10g e=5g e=2g e=1g
External Resolution	1/3000	1/3000~ 1/30000	1/3000	1/3000~ 1/30000	1/3000	1/3000~ 1/30000	1/3000	1/3000~ 1/30000
MAX Tare	-1.4995 kg	-2.999 kg	-2.999 kg	-5.998 kg	-5.998 kg	-14.995 kg	-14.995 kg	-29.990 kg
Display	115 x 35 [mm] / 45 " x 15.5 " 6 digit LCD							
Symbols	STABLE, ZERO, TARE, g, kg, lb, oz, Low Battery HI / OK / LO & PCS							
Keys	ZERO/ UNIT, TARE/ HOLD , MODE,FUNCTION							
Functions	Weighing, Hold, Unit Conversion, Counting-Counting Sample Range : 10~100,200, 500 Weight Comparison Function : hi, ok, low Backlight ON/OFF Control Function							
Dimensions	250 (W) x 281 (D) x 110 (H)[mm] / 984 (W) x 111 (D) x 43 (H)[inch]							
Platter size	226 (W) x 187 (D)[mm] / 88.97 (W) x 73.62 (D)[inch]							
Weight	1.8 kg							
Power	1.5 V x 3 units (D size Battery), Pb 4 V4 A, 6 V Adapter							
Operation Time	Approx. 300 hours (Manganese Battery) / 600 hours (Alkaline at 20 °C /68 °F) / Backlight off							
Operating Temperature	-10 °C ~ +40 °C / 14 °F ~ 104 °F							
Option	6V Adapter 500mA, Pb 4V4A, Rear Display, RS232, USB, SUS TRAY							

※ Notice: Specifications are subject to change for improvement without notice.

RETAIL WEIGHING SOLUTION™



CAS BLDG., #1315, YANGJAE-DAERO,
GANGDONG-GU, SEOUL, KOREA

TEL_ 82 2 2225 3500

FAX_ 82 2 475 4668

www.globalcas.com



9002-SWL-0033-0 2016.11
