



star
TSP100
futurePRNT

ECO

Star | TSP100 *futurePRNT*™ ECO

The World's 1st ECO POS Printer designed to reduce IT Environmental Impact and Operating Expenditure without costing you more

NEW Industry-leading 3 Year Full Warranty (Extend-A-Star)*

star
www.StarMicronics.com

The World's 1st Dedicated ECO POS Printer helping to Reduce IT Environmental Impact & Save Costs.

Here at Star, we've put every waking hour into creating the world's first dedicated ECO POS printer. The TSP100ECO is a POS solution that not only saves you money, but also helps reduce IT environmental impact.

The TSP100 Series offers speeds up to 45 Receipts Per Minute with the new TSP100ECO producing high quality 203 dpi output at a fast 28 Receipts Per Minute.

Contact Star at futurePRNT.com to find out how you can evaluate the latest eco-friendly, receipt printer in the *futurePRNT* range. Offering fast, efficient POS service as well as a unique range of ECO tools and features; all with a manufacturer's pre-paid Carbon Offset program at NO extra cost to you.

Linux™ 

JAVAPOS™

Compatible with  

Designed for Microsoft® Windows® XP

WHQL

OPOS  

ESC/POS™

Compatibility with most major operating systems



Easy-Load "Drop-In & Print", in either the standard horizontal or space-saving vertical position



Full-speed USB interface with serial port emulator for legacy software



Wall mount bracket included with printer at purchase



Robust, high speed guillotine cutter for increased reliability



Optional charcoal grey display stand with in-store A5 graphics facility



Splash Proof Cover option adds extra protection



Value-Added Marketing & Set-up tools that show your business in its best light.

The key to *futurePRNT's* success to date is the combination of a unique software driven, high quality printer sold at an economical price with ground-breaking Retail & Set-up software included in the box.

Create branded and motivating receipts to inspire customers to return with *futurePRNT's* **Receipt Redesign Tools** including:

The **Image Import Tool** can take non pre-sized mono or color bmps, jpgs or gifs and resize / re-dither to the retailer's satisfaction using the **Receipt Pre-View Tool**.

The **Receipt Cropping Tool, Font Replacement Tool, Coupon Marketing Tool and Text Trigger Tool** all work independently of current retail software allowing customers to pre-determine words to "trigger" coupons and graphics.

The **Journal and Multi-Copy Tool** truly demonstrates the versatility of Star software. Not only can the user determine how many copies should be printed, but they can also specify the different text and graphics per copy. The **Journal Function** is for use with software which has no internal electronic journal or where a 2 part dot matrix was previously used.

Reduce multiple printer installation and maintenance time using the **Pre-Installation Set-Up Tool** saving all printer settings, logos, and coupons on the PC itself. The TSP100 Series are truly "Plug and Play" and can be installed right out of the box.

The **Auto-Text Reversal™ Tool**, receipts can easily be turned upside down for user comfort when wall mounted by simply selecting an option in the software or Windows™ printer properties pages.

Further details on all these tools can be found on our website at www.futurePRNT.com



NEW ECO Tools & Features now included in *futurePRNT* Software for the new TSP100ECO Series.

Star has endeavoured to build this printer with every ECO advantage. It is a well-known fact that printers permanently left powered-on waste power. However, it is not so well-known that most of the CO₂ damage caused by any POS printer is actually due to the paper consumed.

Star has therefore researched and put in place unique paper saving features that could help the retailer use **up to 70% less receipt paper**. This not only reduces paper costs but means less frequent paper roll changes at the checkout, lower transportation and logistics costs – basically a win-win situation for the planet and the retailer.

Unique Partial Cut 3mm Default Top Margin

This is not rocket science, but so obvious and so necessary. Star's innovative and experienced engineering expertise has resulted in the TSP100ECO being the only partial cut printer able to achieve a 3mm Top Margin saving 8mm of paper for every receipt printed.

Just calculate the savings yourself. Some competitors cannot even achieve an 11mm Top Margin, so please check this very carefully when comparing competitive POS printers.

11mm



Greene & Brown's
THE ORGANIC PROVISIONS PEOPLE

Date: 17/11/10 20.26

1 x Marmalade	£3.00
1 x Fish Pie	£4.80
2 x Miso Soup	£3.50
1 x Veg Gyoza	£2.50
1 x Cider	£3.50

3mm default



Greene & Brown's
THE ORGANIC PROVISIONS PEOPLE

Date: 17/11/10 20.26

1 x Marmalade	£3.00
1 x Fish Pie	£4.80
2 x Miso Soup	£3.50
1 x Veg Gyoza	£2.50
1 x Cider	£3.50
1 x Organic Ale	£3.20
1 x Sourdough	£3.65
1 x Passata sauce	£5.50

80mm - 58mm Auto Reduction without changing original POS Software

The TSP100ECO can automatically reduce receipts from an 80mm wide format to 58mm without changing the customer's original software set-up. Simply select the required paper reduction in the ECO *futurePRNT* software and you can choose whether to reduce the receipt vertically or horizontally, or both to 72.5% horizontally and 50% vertically.

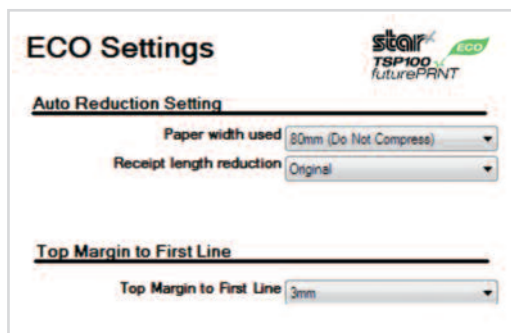
ECO Settings

Auto Reduction Setting

Paper width used: 80mm (Do Not Compress)

Receipt length reduction: Original

Top Margin to First Line

Top Margin to First Line: 3mm



80mm

FRESHCO

Food doesn't get any fresher

5 The Square, Middletown, MT2 5RT
VAT No: 123 4567 89
Tel: 01986 1234569

£

White Mushrooms	1.29
Smoked Salmon	4.99
Baked Beans in Tom Sauce 840g	1.25
Macaroni Cheese 400g	0.93
Gazpacho Soup 745g	3.39
Echo Falls Shiraz 75cl	5.49
After Shave Conditioning Gel	3.49
Fairtrade Bananas	0.99
Organic Skimmed Milk 1L	0.99
Soya Light Milk 1L	1.28
6 Yorkshire Puddings 180g	3.39
Chicken Stock	2.48
Arborio Risotto Rice 500g	2.94
Egg Noodles Medium 300g	1.21
Giant Couscous 300g	1.99
Extra Virgin Olive Oil 1L	7.39
Chocolate Malt Syrup 623g	3.89
Dried Organic Basil 12g	1.89
Grilled Piquillo Peppers 225g	1.98
Sourdough 400g	2.99
Large White Pitta Bread 6	0.89

58mm

FRESHCO

Food doesn't get any fresher

5 The Square, Middletown, MT2 5RT
VAT No: 123 4567 89
Tel: 01986 1234569

£

White Mushrooms	1.29
Smoked Salmon	4.99
Baked Beans in Tom Sauce 840g	1.25
Macaroni Cheese 400g	0.93
Gazpacho Soup 745g	3.39
Echo Falls Shiraz 75cl	5.49
After Shave Conditioning Gel	3.49
Fairtrade Bananas	0.99
Organic Skimmed Milk 1L	0.99
Soya Light Milk 1L	1.28
6 Yorkshire Puddings 180g	3.39
Chicken Stock	2.48
Arborio Risotto Rice 500g	2.94
Egg Noodles Medium 300g	1.21
Giant Couscous 300g	1.99
Extra Virgin Olive Oil 1L	7.39
Chocolate Malt Syrup 623g	3.89
Dried Organic Basil 12g	1.89
Grilled Piquillo Peppers 225g	1.98
Sourdough 400g	2.99
Large White Pitta Bread 6	0.89

72.5%

Reduce your receipts & paper usage without changing your current POS Software.



TSP100ECO Series.

Receipts On Demand Printing

Once again Star has used the clever *futurePRNT* software to produce an **Operator Prompt** to ask the customer whether they need a receipt or not. The receipt can then be either cancelled or printed, perfect for low cost, consumable items such as newspapers, fast food etc. as the receipts are often left behind. All cancelled receipts can be saved graphically and be reviewed or reprinted. (Note: not all countries will allow this feature so the software may be modified on a regional basis).

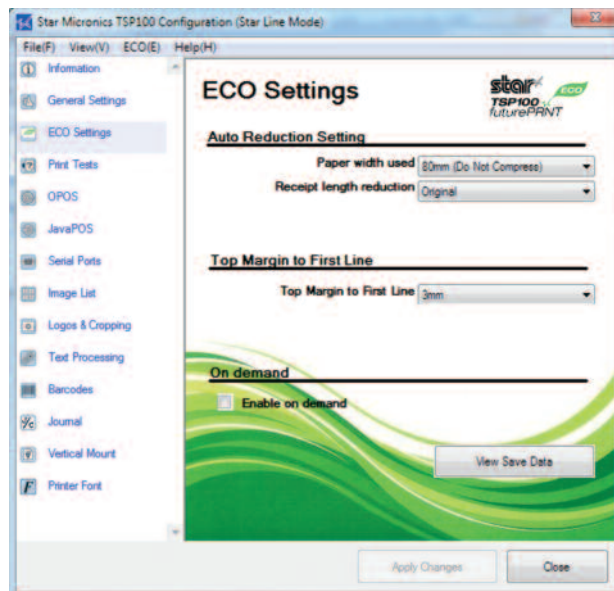
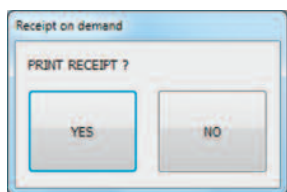
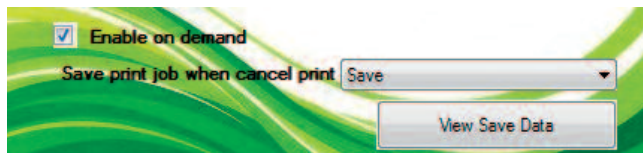

What's in the Box?

Star, as today's most innovative POS printer manufacturer, was the 1st manufacturer to include all installation accessories in the box increasing customer convenience and reducing packaging. (Please see back page for details).

Star has now taken this one step further by eliminating all polystyrene from the box and replacing it with innovative and ethically sourced cardboard packaging. Even the printer's plastic case is made of halogen-free recyclable plastic.

Pre-Installation Set-up Tool

Reduce multiple printer installation and maintenance time using the **Pre-Installation Set-Up Tool** saving all printer settings, logos, coupons on the PC itself. The printer does not need to be taken out of the box and pre-configured before on-site installation.





Use the TSP100ECO while Reducing CO₂

Here at Star, we've built our reputation on producing high quality POS printing solutions at low prices. And, with the launch of the TSP100ECO, we've taken that commitment on in leaps and bounds by creating a POS printer that's not only friendlier on the pocket but also on the environment too.

Carbon offsetting is the responsible way to compensate for the unavoidable CO₂ emissions from our daily lives and economic activities by supporting the projects that deliver the equivalent CO₂ savings elsewhere.

Star Micronics has therefore purchased Certified Emission Reductions (CERS) carbon credits derived from the Clean Development Mechanism (CDM) projects as defined by the Kyoto Protocol and registered by CDM Executive Board of UN. The carbon credits purchased will offset the CO₂ emissions emitted from the TSP100ECO manufacturing & disposal process and projected power consumption for up to 5 years (total 33.9 kg/unit). The CERs used will then be cancelled to complete the offsetting process.

More details can be found on www.futurePRNT.com including the opportunity to register all ECO printer purchases and print certificates to show how your company is helping to minimize environmental damage from IT activities.

Star ECO Impact Analysis Tool

Work out how much money and environmental damage you can save by using the Star Impact Analysis Tool in Dollars, Euros, Sterling or Yen!

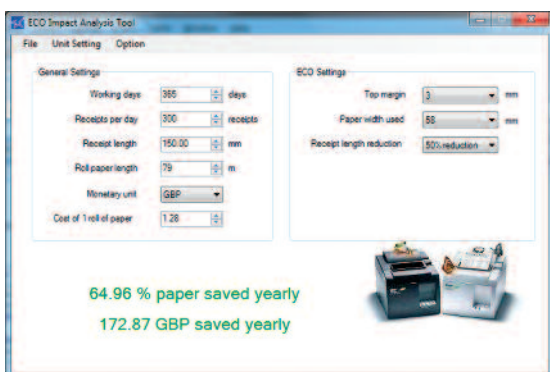

More details on www.futurePRNT.com



TSP100ECO Power Management.

Inspired by the Cheetah, nature's greatest exponent of energy efficiency, we've put every waking hour into creating the most environmentally friendly POS printer money can buy. The TSP100ECO uses up to 40% less power than the majority of competitive printers available today.

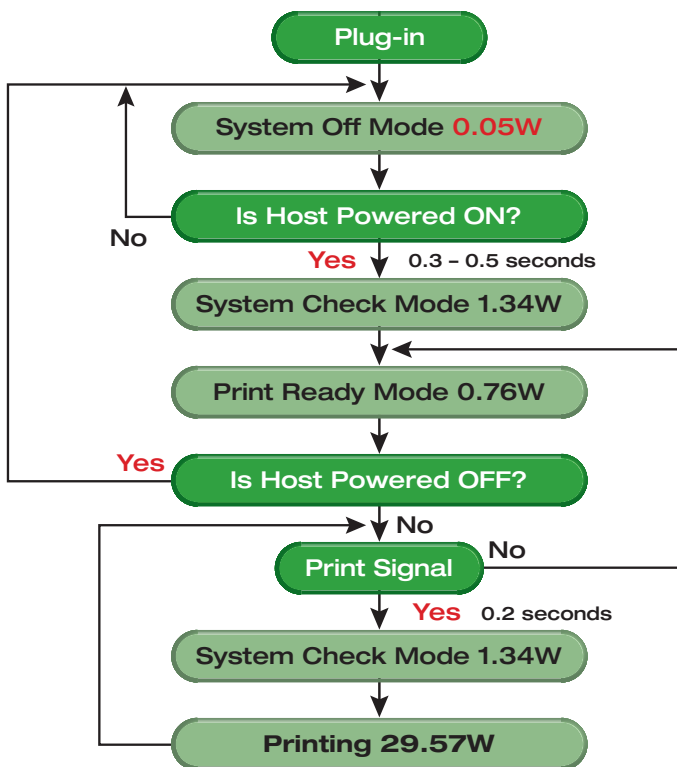

Those clever engineers at Star have designed this printer to correspond directly to the PC it has been attached to. Users will first of all notice that there is no power switch and that the printer can only be turned on by actually attaching the included USB cable to the printer and PC / terminal. The printer will only activate when the PC / terminal is powered up otherwise it can remain in standby mode, thus saving power.

Most POS printers spend the major part of a day drawing current, but not printing. Star's new power efficient method means the printer will revert with the PC to a very low powered standby mode when not in use, "instantly" waking up when needed saving costs and power usage.

The TSP100ECO is fully ENERGY STAR® Qualified



New Industry-leading 3 Year Full Warranty *(Extend-A-Star) on the TSP100ECO. Swap-A-Star FREE for the First Year. (U.S. and Canada)

www.futurePRNT.com

TSP100 Series Summary

NEW TSP143ECO

150mm/second *(28RPM)
Autocutter USB model

TSP113GT

250mm/second *(45RPM)
USB Tear Bar model

TSP143GT

250mm/second *(45RPM)
USB Autocutter model

TSP113LAN

125mm/second *(22RPM)
Ethernet Tear Bar model

TSP143LAN

125mm/second *(22RPM)
Ethernet Autocutter model

TSP113PUSB

125mm/second *(22RPM)
PoweredUSB Tear Bar model

TSP143PUSB

125mm/second *(22RPM)
PoweredUSB Autocutter model

TSP113U

125mm/second *(22RPM)
USB Tear Bar model



TSP100GT

Original 250mm per second USB version of the TSP100 *futurePRINT* Series with full gloss Piano Black or Ice White Casing and power / USB cables included at purchase.



TSP100LAN

The world's first entry-level dedicated Ethernet printer with LAN cable included.

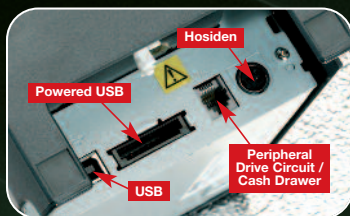

TSP100PoweredUSB

The world's first entry-level dedicated PoweredUSB printer able to use either standard USB and hosiden connector power cable or Powered USB cable combining both functions. (Please note there are no power or interface cables included in the box with the PUSB model.)

Technical Specifications

Printer Method	Direct Thermal Line Printing
Traditional Print Speed	TSP100ECO – 150mm/second *(28RPM) TSP100U, TSP100PUSB, TSP100LAN – 125mm/second *(22RPM), TSP100GT – 250mm/second *(45RPM)
Printer Case Color	TSP143ECO, TSP100U, TSP100LAN, TSP100PUSB Star White or Charcoal Grey. Other colours available for larger volume orders. TSP100GT full gloss Piano Black or Ice White
Print Resolution	203 dpi (8 dots per mm)
Two Color Print Capability	Red / Black, Blue / Black (special paper required)
No. of Columns (maximum)	Star Mode = 48. ESC/POS™ Font A 42 Font B 56
Character Set	ANK 95, 32 Int 128 Graphic plus Chinese, Japanese, Korean, Taiwanese
International Code Pages	Star Mode = 40 + 1 blank, ESC/POS™ Mode = 10 + 1 blank allowing an additional character page to be added
Barcodes	Extended barcode functionality – 9 versions including QR (PDF417 & Maxicode pending)
Line Spacing	3mm or 4mm + programmable
Paper Specifications:	
Width	80mm Standard, 58mm with guide fitted
Thickness / Weight	0.065mm ~ 0.085mm
Roll Diameter	up to 83mm
Easy-Load	"Drop-In & Print"
Paper Out Sensor	Standard
Maximum Print Width	80mm paper = 72mm, 58mm paper = 50.8mm
Top Margin	TSP100ECO 3mm default with 11mm selectable option. All other TSP100 models 11mm
Autocutter	Guillotine (Partial Cut Only)
Logo Store Capacity	Unlimited
Drivers Available	Windows™ 7 (+64bit support) / Vista™ (+64 bit) / 2000 / XP / XP Embedded / WePOS / CE, Windows™ 98/ME/NT4 (download only), Linux™, Mac OS X, OPOS™, Java-POS™, CUPS™, POS for.Net, USB Vendor Class, Star IO
Interface / Port:	All models feature a selectable "Virtual" Serial Port emulator
TSP100U / GT / ECO	USB 2.0 Full Speed with cable supplied
TSP100LAN	Ethernet (10/100BaseT, UTP) with cable supplied
TSP100 Powered USB	Combined Power and USB cable version (cables not supplied)
Emulation	Star Mode, ESC/POS™
Peripheral Drive Circuit	2 circuits (24V max.1A), 1 Compulsion input
Power Consumption	TSP100ECO please see page 3 All other TSP100 models Average 1.6amp. Printing, 0.1 Amp. Standby.
Power Supply	Internal with power cable supplied (not TSP100PUSB)
Operating / Storage Conditions:	
Temperature	5°C to 45°C / -20°C to 60°C
Humidity	10% to 90% RH (without condensation)
Dimensions	142mm (W) x 204mm (D) x 132mm (H)
Weight:	
Autocutter Models (Guillotine)	TSP143U – 1.73Kg, TSP143GT – 1.76Kg, TSP143PUSB – 1.53Kg, TSP143LAN – 1.72Kg, TSP143 ECO – 1.72Kg
Tear Bar Models	TSP113U – 1.56Kg, TSP113GT – 1.59Kg, TSP113PUSB – 1.37Kg, TSP113LAN – 1.56Kg
Safety Standards	UL, C-UL, TÜV, FCC, VCCI, EN55022, CE
Reliability:	
MCBF	60 million lines
Print head	100km
Cutter (Guillotine)	1 million cuts
Accessories included with the printer	Wall Mount Bracket Auto-Reverse Text Output Software Vertical Upper Guide (TSP100ECO only) 58mm Paper Guide 1.8m Interface Cable 1.8m Power Cable Installation CD and <i>futurePRINT</i> Retail Marketing and Set-up Software (Interface and Power cables not included with PUSB versions)
Options	Splash Proof Cover Vertical Stand Buzzer

*RPM: Receipts Per Minute

Star encourage electronic distribution of this flyer to further reduce environmental damage.

Star Micronics America, Inc, 1150 King Georges Post Road, Edison New Jersey 08837
Telephone: 800-782-7636 Email: sales@StarMicronics.com

star
www.StarMicronics.com